

Introduction of Dosimetry

Okky Agassy Firmansyah

oafirmansyah@gmail.com

okky001@brin.go.id

+6281-210-698-624

Pelatihan Petugas Iradiator

Direktorat Pengembangan Kompetensi BRIN - 2025

Profile

- Nama: Okky Agassy Firmansyah
- Kota Kelahiran: Nganjuk
- Riwayat Pendidikan:
 - **D3** Metrologi dan Instrumentasi, ITS Surabaya
 - **S1** Teknik Fisika, ITS Surabaya
 - **S2** Medical Physics, UST South Korea
 - **S3** Ilmu Fisika, Universitas Indonesia (on-going)
- Bidang minat: **Metrologi Radiasi Pengion**
- Email: oafirmansyah@gmail.com
- Phone: 081210698624



Experiences:

- Global Metrology Academy (GMA), Korea Research Institute of Standard and Science (2019)
- Mahasiswa Peneliti di Laboratorium Dosimetri Standar Primer KRISS South Korea (2020-2022)
- Monte Carlo Beginner and Advance Training Course for PHITS MC Code (2023-2024)
- Fellowship Dosimetry at Institute Nuclear Chemistry and Technology, Poland (2023)
- Expert Mission program on High-dose rate, Florent Kuntz, Aerial France (2023)
- Expert Mission program on High-dose rate, Marta Walo, INCT Poland (2023)
- Expert Mission program on Puffin Monte Carlo modelling from PNNL US, Serpong (2024)
- Australian Awards: Phytosanitary Irradiation (2025)
- Fellowship Dosimetry at National Research Council, Canada (2025)

Single-Side Irradiation of mango (Gamma vs Electron)

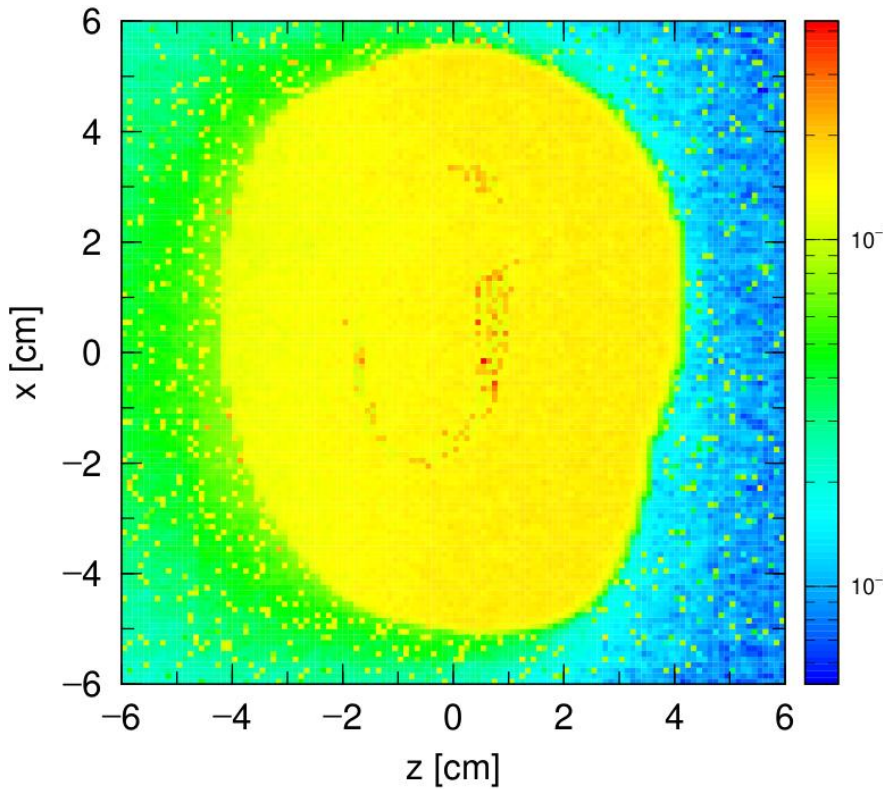

Sumber Co-60

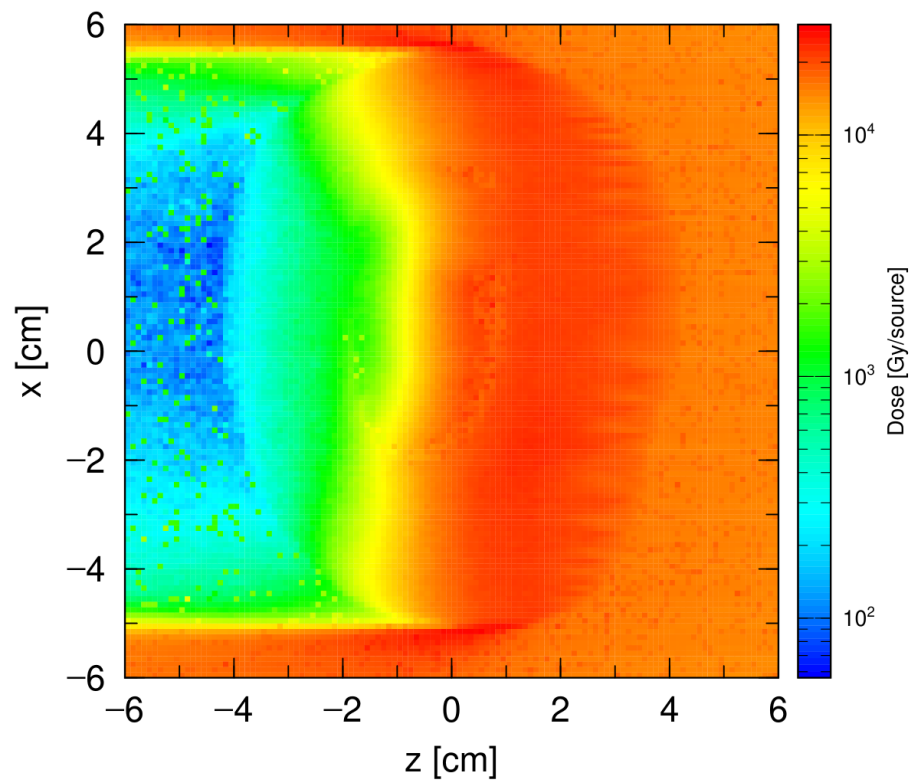

Sumber Elektron 10 MeV

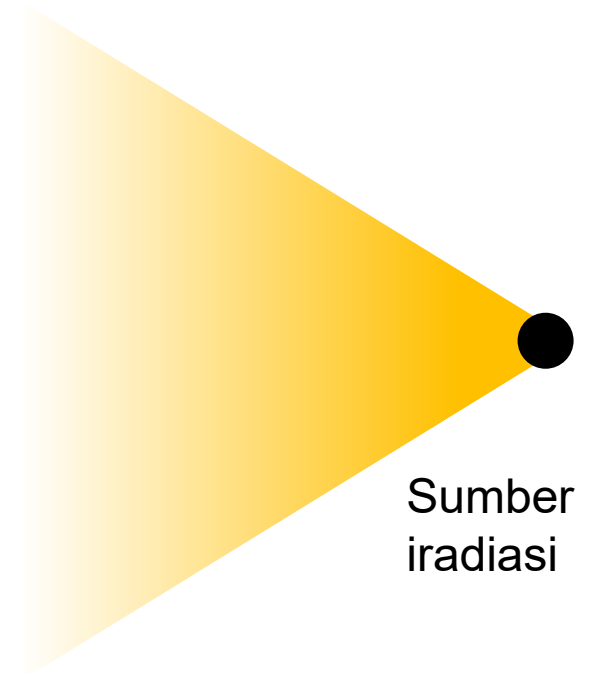

Distribusi dosis (Gy/source) pada buah mangga dengan arah sumber radiasi dari Z+ untuk (a) sumber gamma dan (b) elektron 10 MeV

E-Beam 10 MeV

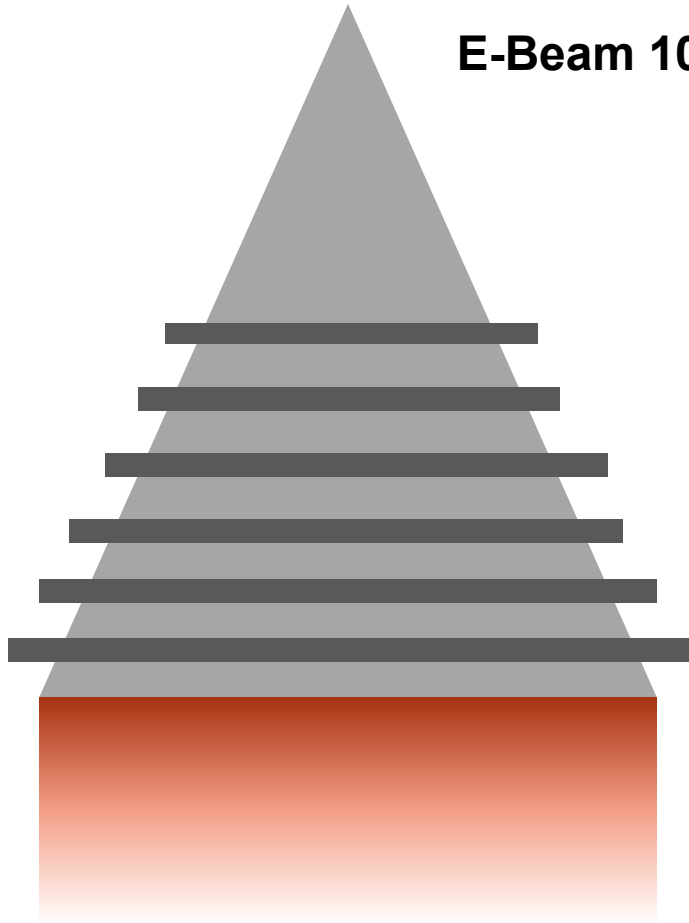

BOX

Dose at Box's surface = ~ 418 Gy

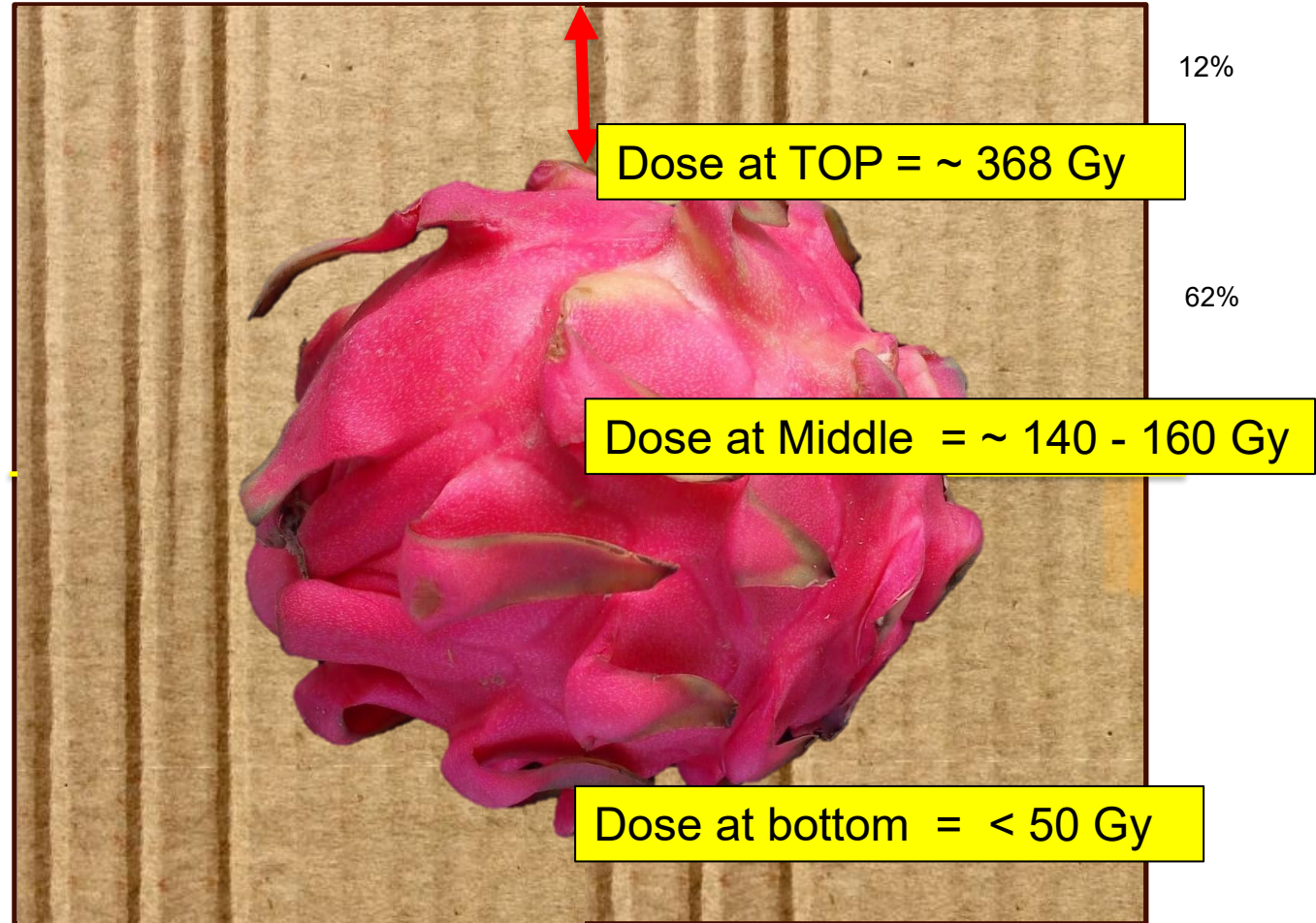

Cable Irradiation

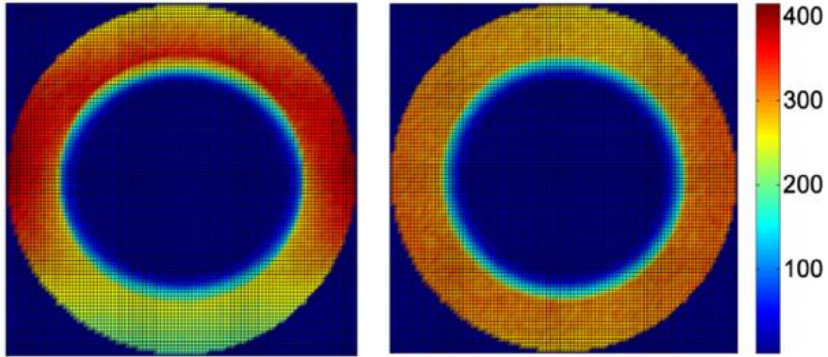

(a)

(b)

- a) Dose distribution of the starting irradiation in racetrack
- b) Dose distribution when the effect of random cable rotations during passes is considered

(Luigi Mangiacapra, 2013)

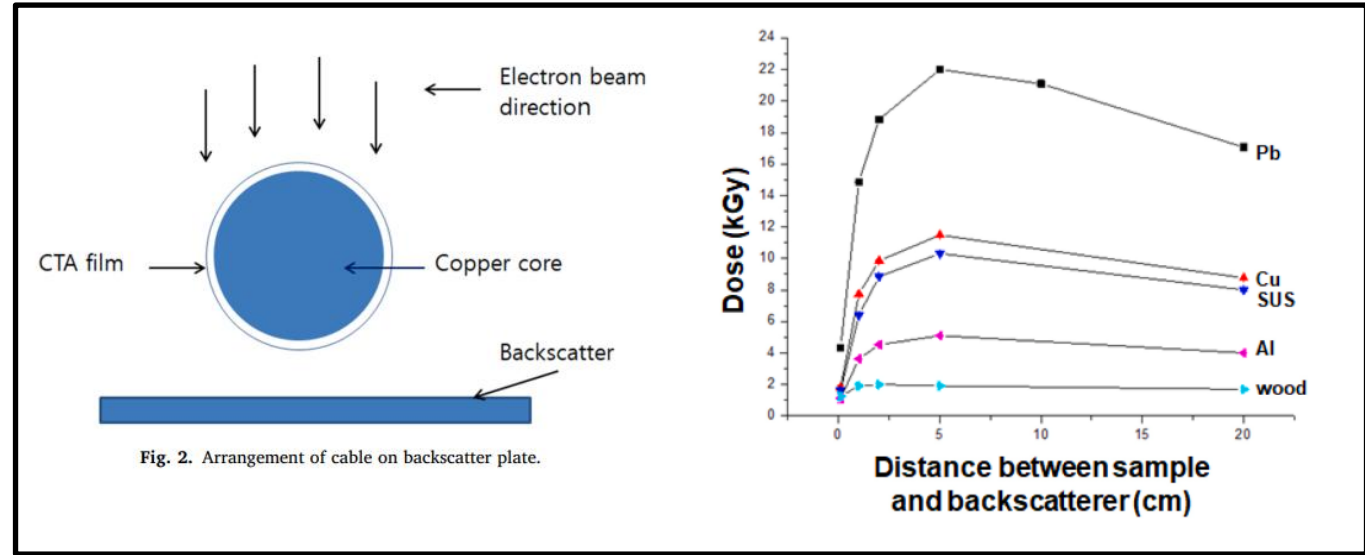

Relation of backscattering and distance between sample and back scatter: Plate Size: 80 × 80 cm² (Seung-Tae Jung, 2022)

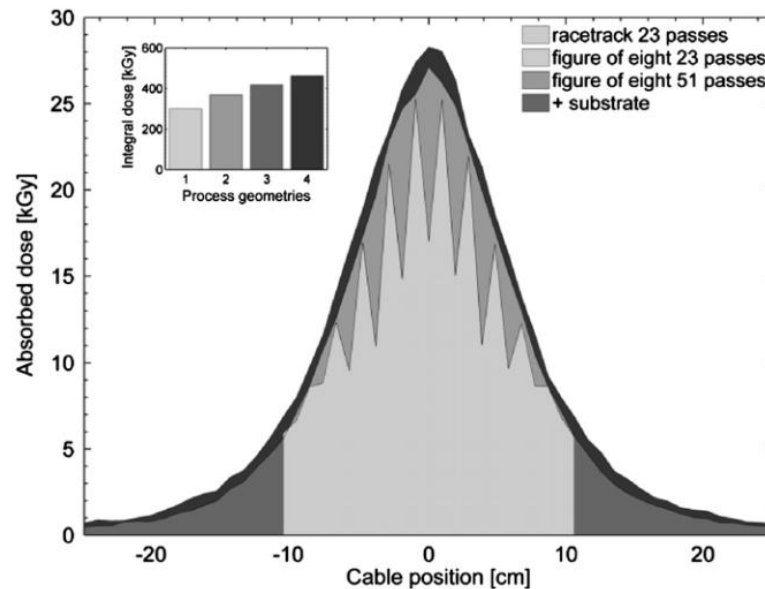

Distributions of mean doses per pass of the cable in Fig. 6 irradiated with four geometrical setup.

(Luigi Mangiacapra, 2013)

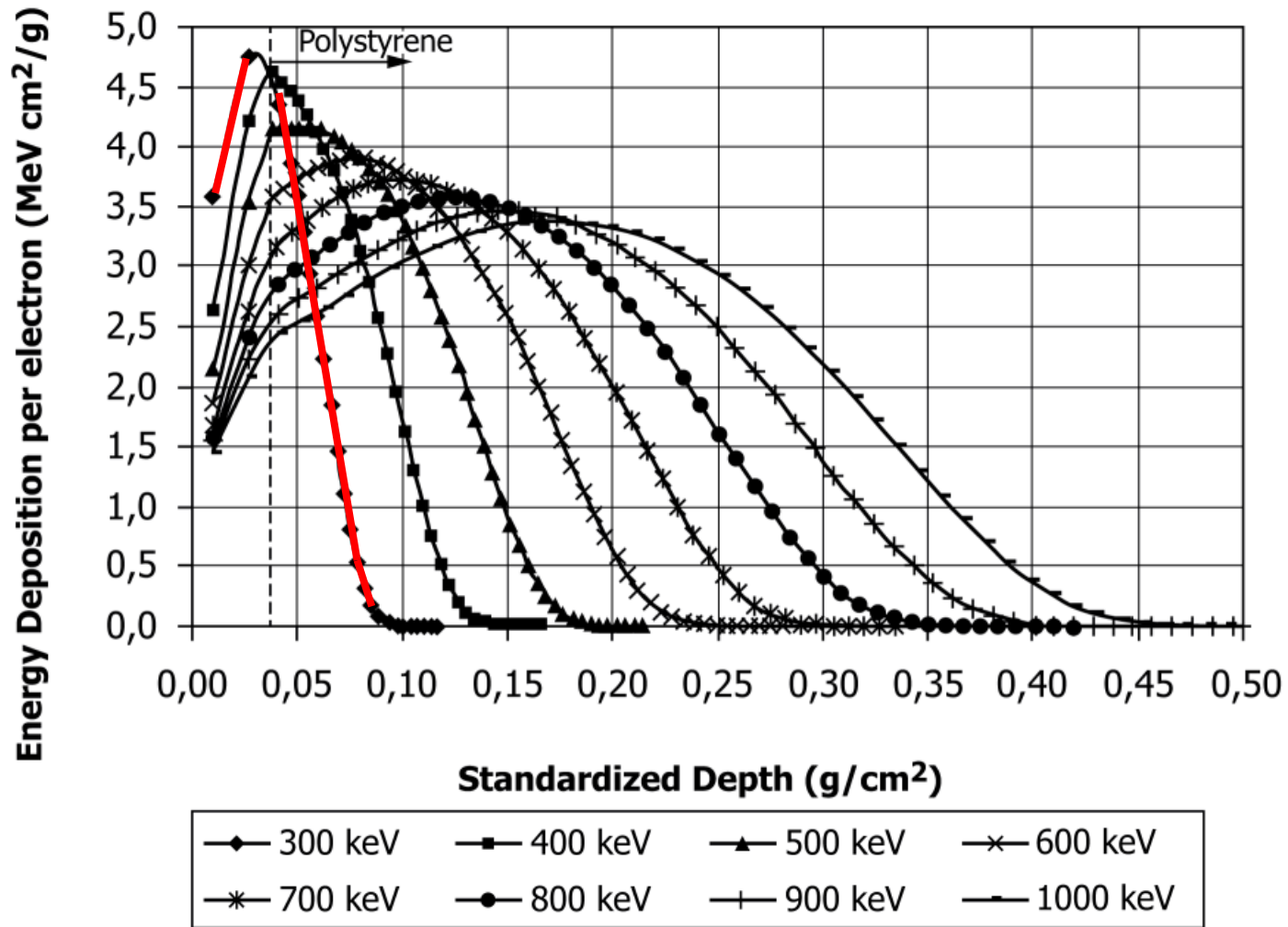

Dari kurva **300 keV (marker ♦)** pada gambar itu, puncak deposisi energi (**dmax**) terjadi **tepat di sekitar garis putus-putus**, yaitu pada **standardized depth $\approx 0,040 \text{ g/cm}^2$**

Densitas polystyrene:

$$\rho \approx 1,05 \text{ g/cm}^3$$

$$Z_{max} = \frac{0,004}{1,05} = 0,0038 \text{ cm} = 0,038 \text{ mm}$$

NOTE 1—The window is assumed to be 4×10^{-5} m thick titanium (0.018 g/cm^2) followed by 0.15 m of air (0.018 g/cm^2). The first Monte Carlo calculated data point of these curves represents the energy deposition in the titanium window and the second set of data points represents the energy deposition in the air space. The third data points correspond to the energy deposition at the surface of the irradiated material.

FIG. A2.3 Calculated depth-dose distributions in polystyrene for normally incident electrons at monoenergetic energies from 300 to 1000 keV using the Program ITS3 (20)

Tujuan Pembelajaran

Hasil Belajar: peserta mampu menjelaskan mengenai sistem dosimetri

- **Indikator Hasil Belajar:**
 - mampu menjelaskan **teori dasar dosimetri**.
 - mampu menjelaskan **jenis dosimeter**.
 - mampu menjelaskan **sistem kalibrasi dosimeter**.

Scan QR dengan gadget Anda

Ayo interaktif!

<https://www.menti.com/al93sy13yqak>



Outline

1. Teori Dasar Dosimetri
2. Dosimeter dan faktor-faktor yang mempengaruhi pengukuran
3. Kalibrasi dan Ketertelusuran
4. Ketidakpastian pengukuran

Pertanyaan Pendahuluan?

1. What is Dosimetry?

Dosimetry is the process of measuring the amount of radiation received by a product during irradiation.

In a **quality system**, dosimetry plays a key role by providing:

- Accurate measurement
- Confidence level of the process
- Clear records to show that the irradiation was done correctly

2. What type of dosimeter do you use?

Ion Chamber, Calorimeter, Alanine, B3 Film, PMMA Harwell, CTA Film, etc.

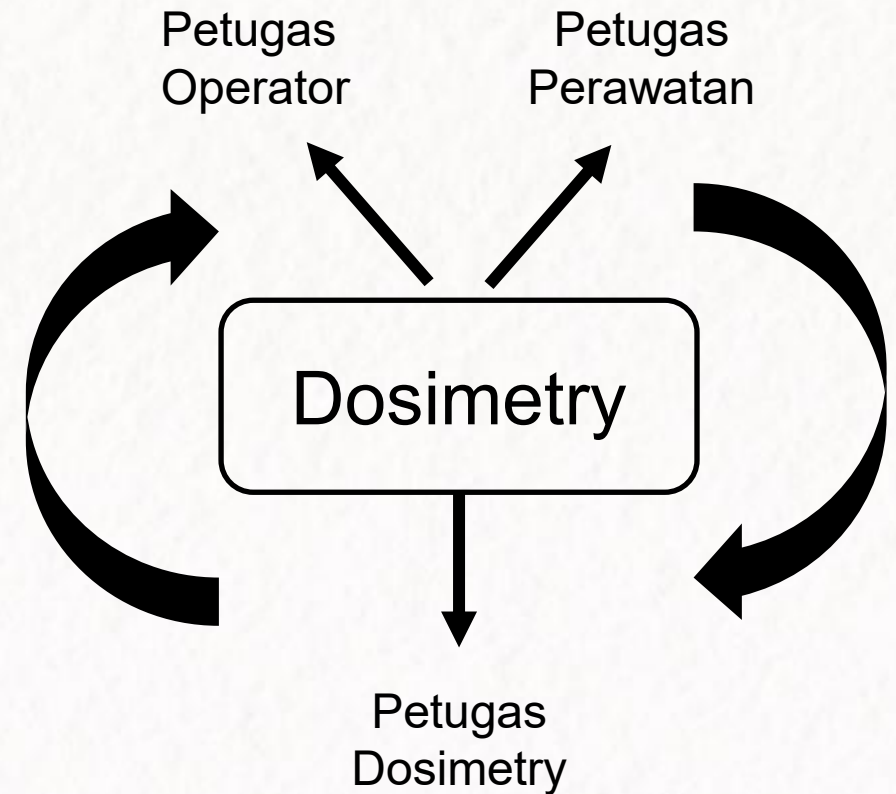



A history

Indonesian Project History

Exported Country



Tropical Fruit Commodity

AUSTRALIA

Imported Country

Pra-syarat ekspor:

Kewajiban untuk memenuhi regulasi **FITOSANITARI** mengenai karantina buah dan tumbuhan untuk pencegahan masuknya OPT dari luar negeri.

*OPT (Organisme Pengganggu Tumbuhan)



Fruit Flies
150 Gy



Mealybug
150 Gy



Mango Seed Weevil
400 Gy



Mango Caterpillar
300 Gy

(Humayra Akter, 2023)



Tiga **keberterimaan** Fitosanitari Iradiasi:

1. OPT menjadi **MATI**
2. Perkembangbiakan OPT dapat **DICEGAH**
3. OPT tidak dapat bereproduksi (**STERIL**)

RADIASI PENGION



Buah terkena radiasi
(healthjade.com)

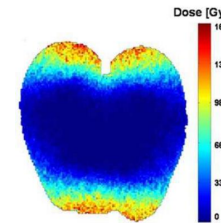
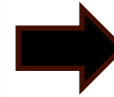

Dosis **terdistribusi** pada buah
(Jongsoon Kim, 2005)



Disinfestasi Serangga
(naads.or.ug)

Generic dose for phytosanitary Irradiation is **400 Gy** (G. J. Hallman, 2012)

Parameter QA Treatments:

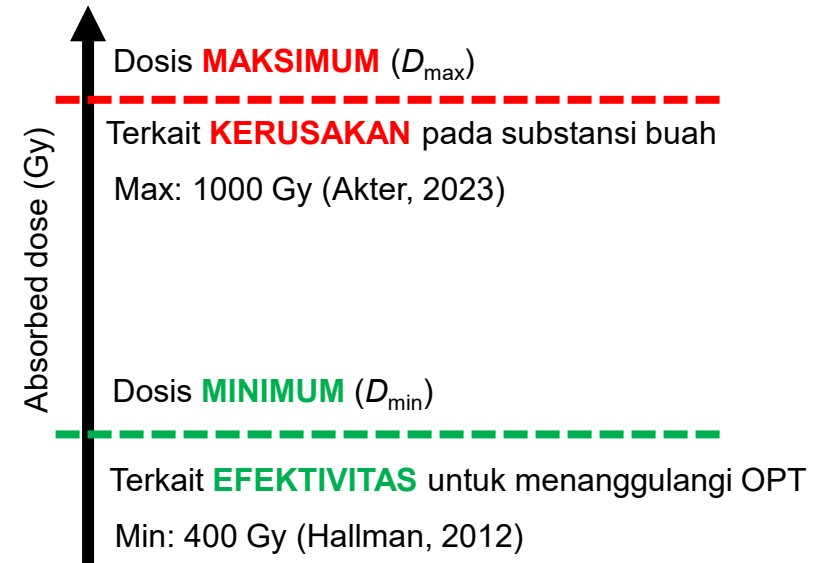

Indonesian Project History

Vietnamese fresh fruits are irradiated for export

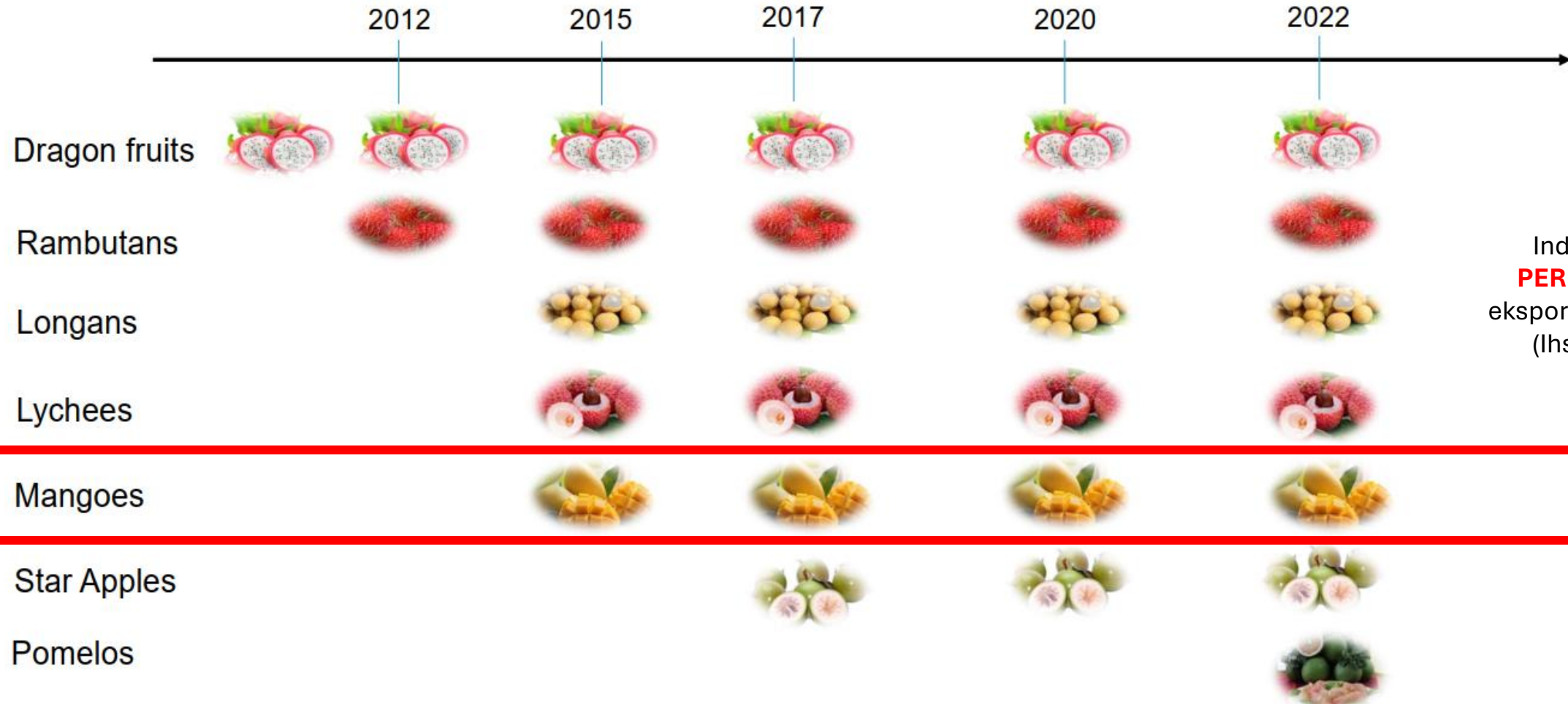

Indonesia **BELUM**
PERNAH melakukan
ekspor buah hasil iradiasi
(Ihsanullah, 2017)

Indonesian Project History



Highlight:

1. **Regulasi** Badan Karantina yang belum siap
2. **Diseminasi** perlakuan fitosanitari iradiasi yang belum optimal
3. Kualitas Radiasi (**DOSIMETRI SISTEM**) yang belum proper



Satu-satunya aspek yang bisa dijamin oleh fasilitas iradiasi adalah **DOSIS yang presisi dan **TERTELUSUR** ke standar internasional**

“Petugas dosimetri adalah tulang punggung fasilitas dalam pelaksanaan jaminan mutu irdiasinya”



1

Fundamental Dosimetry (*Refreshment*)

Why it is important?

Kenapa kita harus tau terlebih dahulu besaran fisika apa yang hendak kita ukur?



Biar tidak salah ukur

Jenis-jenis Berkas Radiasi

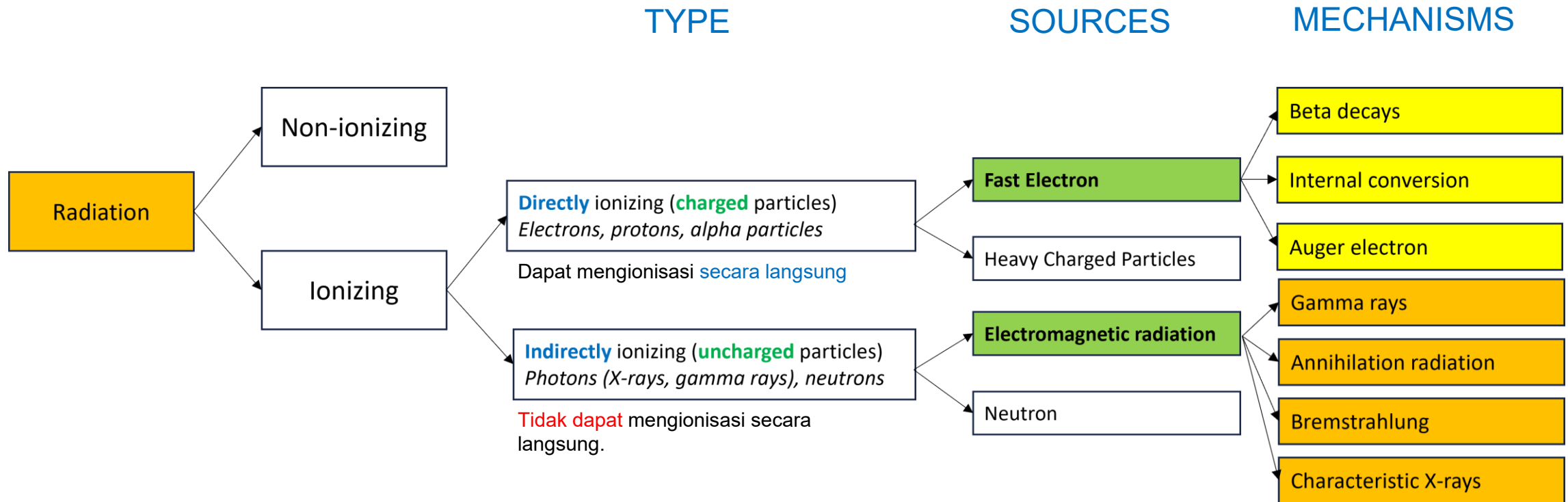

Berkas radiasi yang digunakan di level Industri

Berkas **elektron** Digenerasi oleh **Mesin berkas elektron** (MBE)

Sinar **Gamma** **Radionuklida** Cobalt-60

Sinar-**X** MBE dengan tambahan **konverter**

Interaksi Radiasi dengan Materi

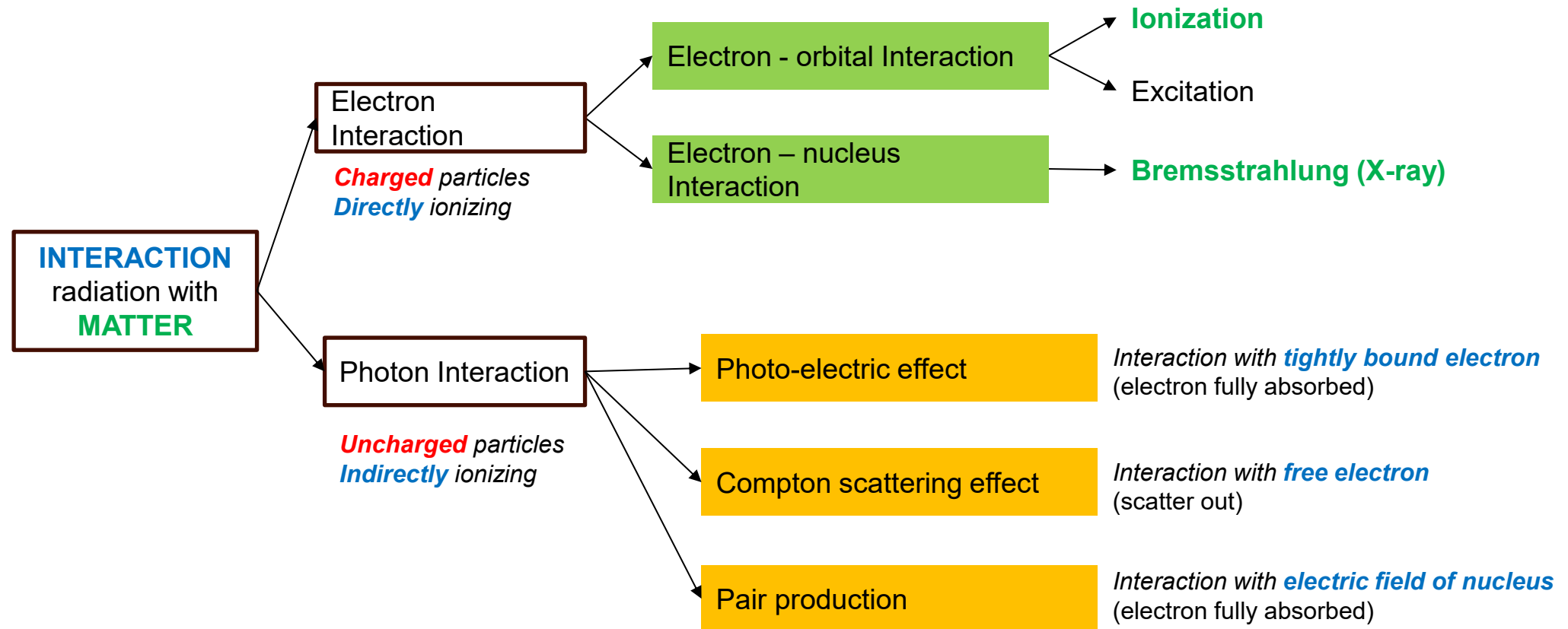

Alur Transfer Energi

Through several mechanisms

1. Photo-electric
2. Compton scattering
3. Pair production

Uncharged Particles

Gamma
X-ray

Create

Charged Particles

Electron

Energy deposited
in any medium

Through several interaction

1. Mass-collisional stopping power
2. Mass-radiative stopping power

High **atomic number**, high-**density materials** will consequently result in the greatest linear stopping power

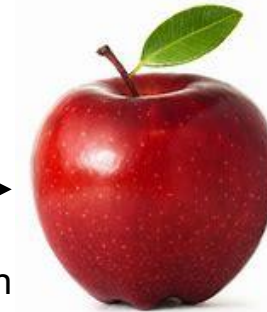

Measurand:

ABSORBED DOSE

Dose D in the medium:

$$D = \phi(S/\rho)_{\text{col}}$$

Φ = fluence

The type of material is **IMPORTANT!**

Alur Transfer Energi

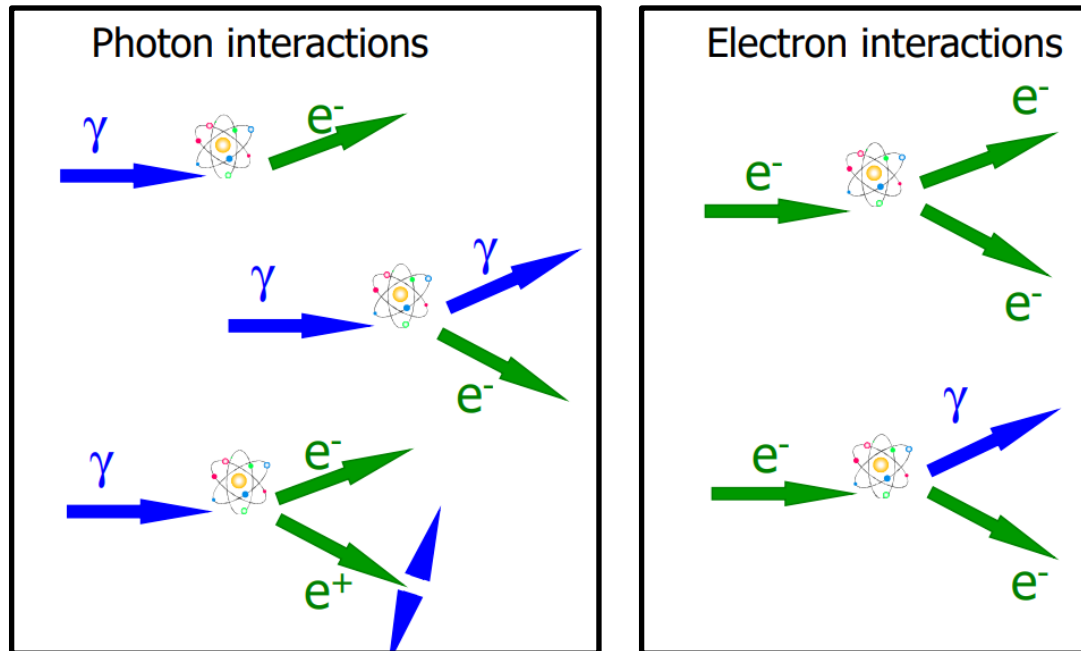

⇒ Interaction process leads to secondary electrons

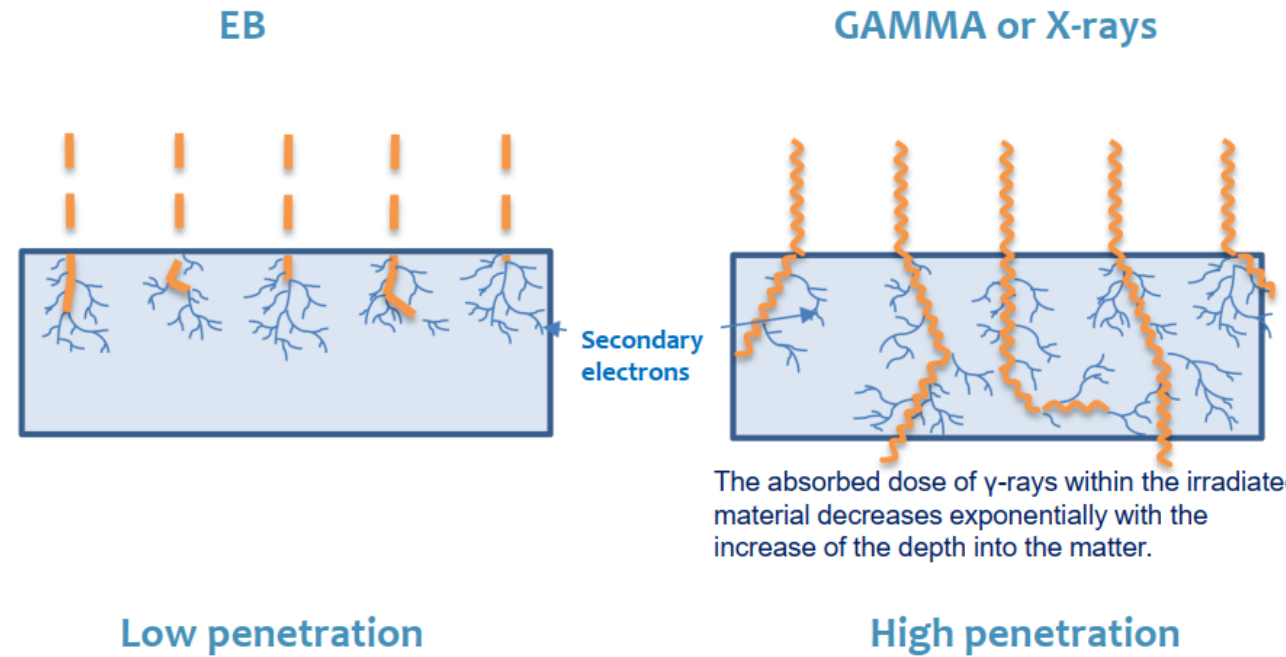

Yang berkontribusi terhadap dosis adalah **Charged Particles**.

KERMA vs Absorbed Dose

The unit is joule per kilogram (J/kg)

Name: **Gray (Gy)**

KERMA (*kinetic energy release per unit mass*)

Average amount of energy **TRANSFERRED** from the indirectly ionizing radiation to directly ionizing radiation **without concerns** to what happens after this transfer.

$$K = \frac{d\bar{E}_{tr}}{d_m}$$

Energy transfer
(energy yang ditransfer)

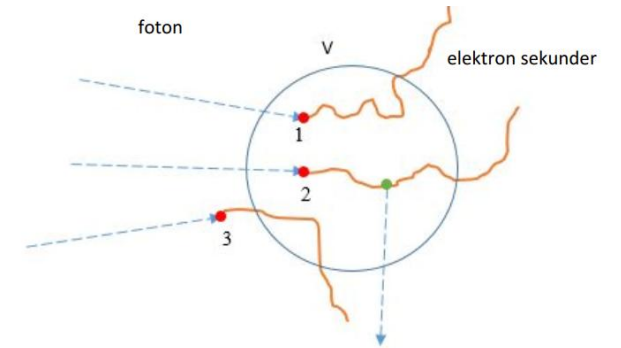

ABSORBED DOSE

The absorbed dose is defined as the mean energy **IMPARTED** by ionizing radiation to matter of mass m in a finite volume V

$$D = \frac{d\bar{\epsilon}}{d_m}$$

Energy imparted
(energy ter-serap)

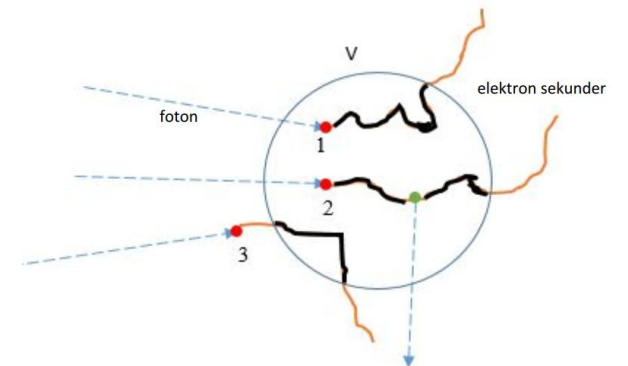

Apakah dosis pada objek yang diiradiasi dapat diketahui dengan survey meter?



Tidak bisa!

KERMA vs Absorbed Dose

KERMA (*kinetic energy release per unit mass*)

1. Average amount of energy **TRANSFERRED**
2. Transfer energy from **UNCHARGED PARTICLES** to charged particles by KERMA collision
3. Characterized by **mass-energy TRANSFER** coefficient and
4. using **ENERGY FLUENCE Ψ**
5. The matter of **SENDER**

ABSORBED DOSE

1. Average amount of energy **ABSORBED**
2. Energy loss by **CHARGED PARTICLES** by collision interaction
3. Characterized by **STOPPING POWER** and
4. Using **PARTICLE FLUENCE Φ**
5. The matter of **RECEIVER**

KERMA vs Absorbed Dose

Grafik Percentage Depth Dose (PDD) – Distribusi Dosis di kedalaman sebuah materi

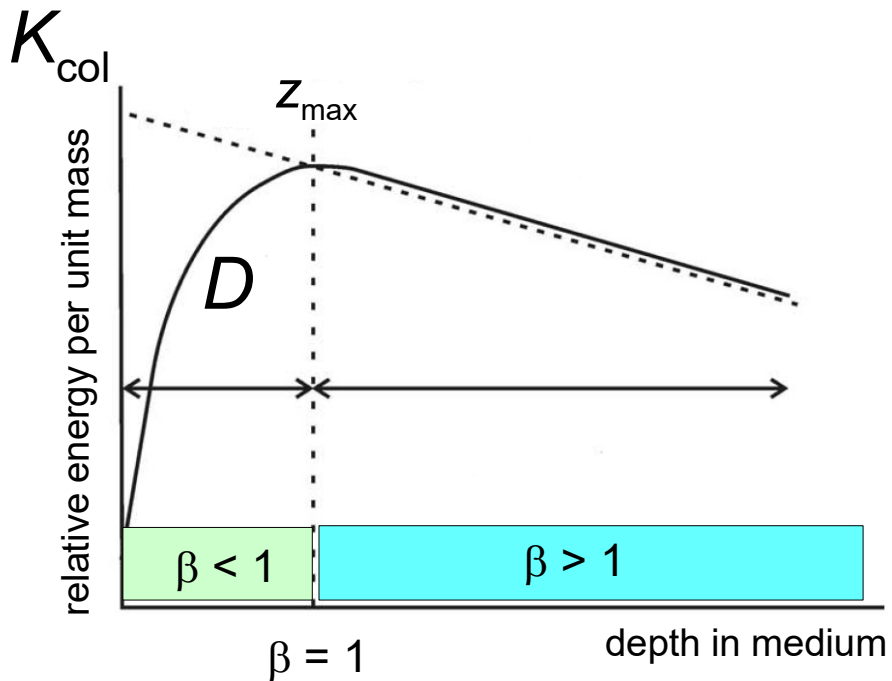

In the buildup region:
 $\beta < 1$

In the region of a transient charged particle equilibrium:
 $\beta > 1$

At the depth $z = z_{max}$, a true charged particle equilibrium exists.
 $\beta = 1$

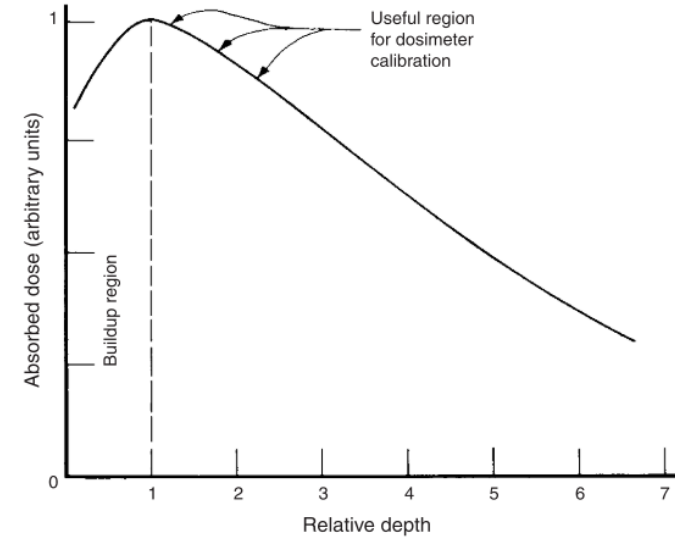

Note:

1. Kalibrasi **HARUS** dilakukan di daerah **CPE**
2. Dosis **MAKSIMUM** tidak terletak di **PERMUKAAN**

^{137}Cs γ rays ($E_\gamma = 0.66$ MeV)	3 mm of water (= 0.3 g/cm ² , 3 kg/m ²)
^{60}Co γ rays ($E_\gamma \approx 1.25$ MeV) ⁵	5 mm of water (= 0.5 g/cm ² , 5 kg/m ²)
4 MeV X rays	10 mm of water (= 1.0 g/cm ² , 10 kg/m ²)
6 MeV X rays	16 mm of water (= 1.6 g/cm ² , 16 kg/m ²)
10 MeV X rays	30 mm of water (= 3.0 g/cm ² , 30 kg/m ²)

IAEA TRS No. 409: Dosimetry for Food Irradiation (IAEA, 2002)

Radiation Oncology Physics: A Handbook for Teachers and Students.
Podgorsak, Ervin B. (2004)

KERMA vs Absorbed Dose

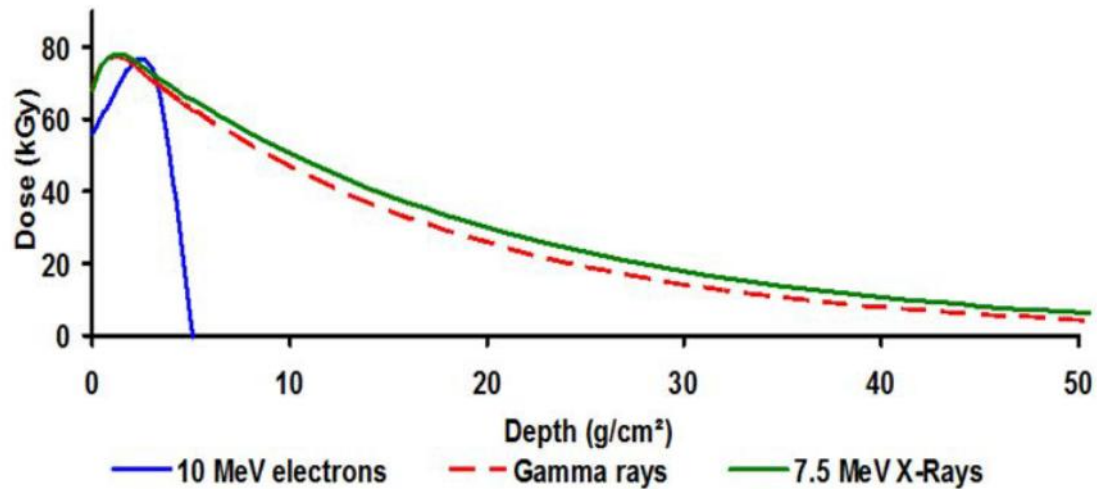

Phantom E-beam GEX

IAEA TRS No. 481 Manual of good practice in food irradiation: sanitary, phytosanitary and other applications

- Bahwa masing-masing modalitas iradiasi memiliki **karakterisasi depth dose** yang berbeda.
- **Mass density** dari material akan mempengaruhi dari distribusi dosis di kedalaman
- Hubungannya adalah **estimasi dosis** untuk treatment/proses iradiasi yang akan kita lakukan



Phantom E-beam RISO

KERMA vs Absorbed Dose



Phantom Gamma by GEX Corporation

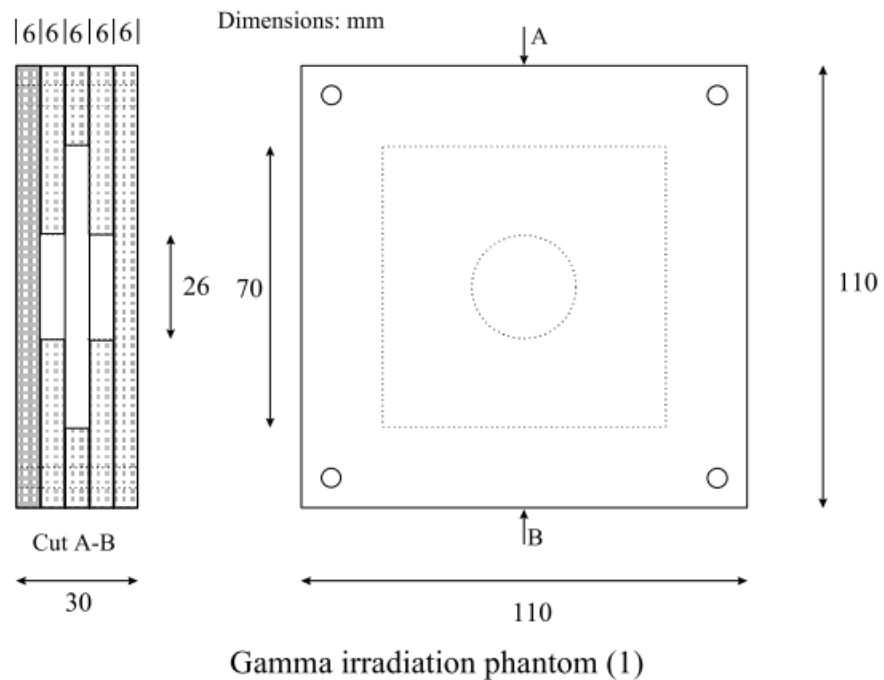

Schematic of Phantom Gamma (CIRM No 29)



Phantom Gamma by INCT Poland

Pit Stop

- Apa perbedaan mendasar antara Kerma dan Absorbed Dose?
- Kenapa kita butuh phantom untuk pengukuran dosis?
- Apakah dosis serap bisa diukur dengan menggunakan personal dosimeter?

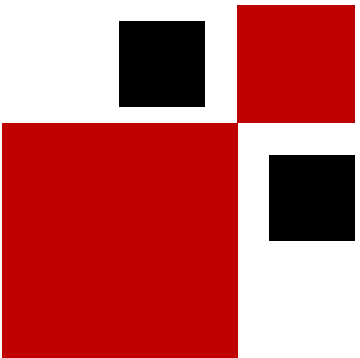



2

Dosimeter dan Faktor - faktor yang mempengaruhi pengukuran

Influence Factor: Accuracy vs Precision

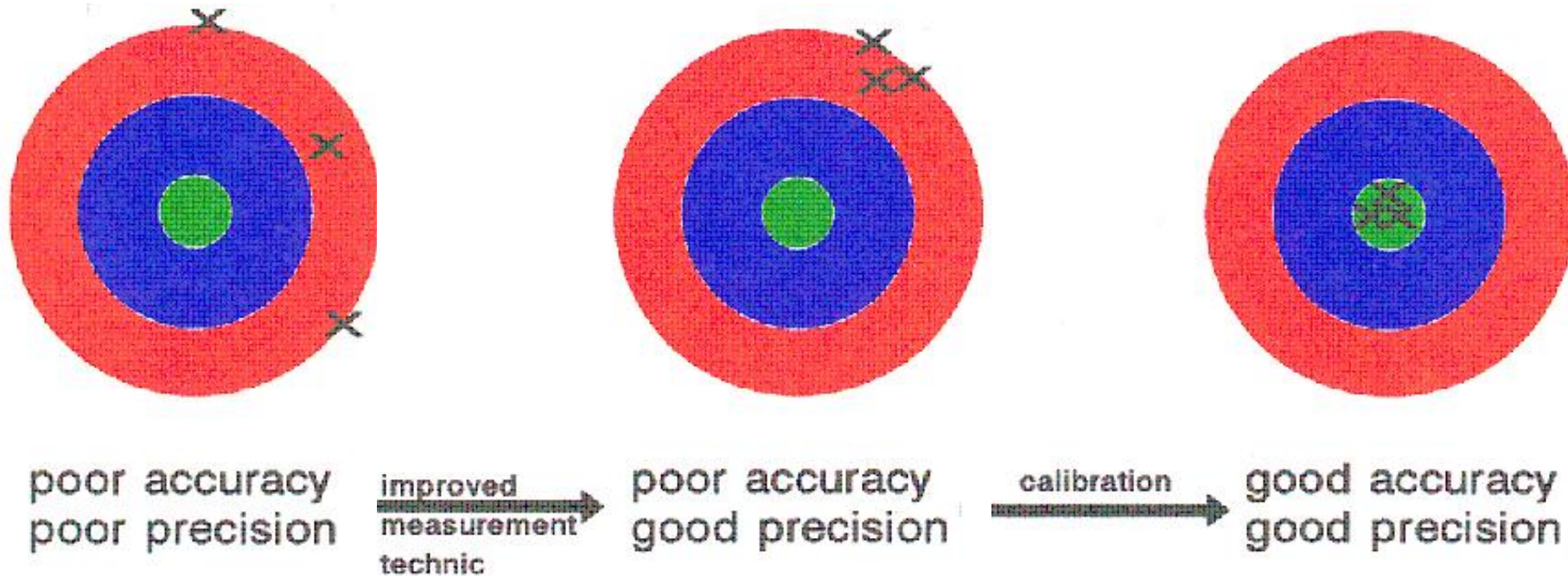

- ACCURATE – Near the true value/ reference value
- PRECISION – Good repeatability (**standard deviation/square root of number of measurements**)

Apa itu Dosimeter?

Dosimeter in Radiation Processing



Alanine Dosimeter

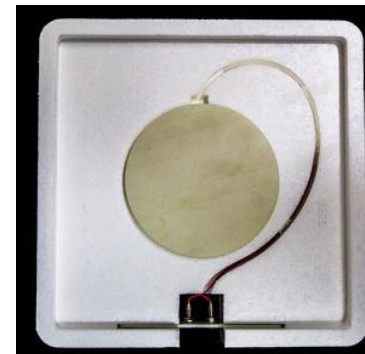

Calorimeter



Amber Perspex
PMMA



B3 Film GEX

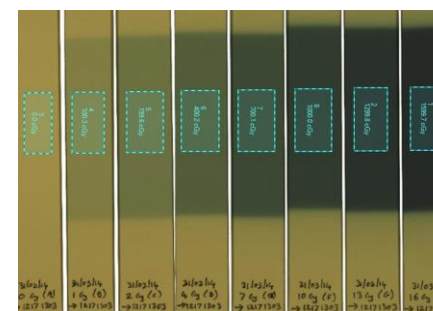

Gafchromic Film



CTA Film

Dosimeter in Radiation Processing

Dose measurements depend on various methods:

- ❑ *Temperature increase* (calorimeters);
- ❑ *Colour change* (perspex, radiochromic systems-CTA);
- ❑ *Free radical concentration* (alanine);
- ❑ *Conductivity change* (ECB, alanine solution);
- ❑ *Radiation chemical oxidation* (Fricke);
- ❑ *Radiation chemical reduction* (dichromate, ceric-cerous);
- ❑ *Optically stimulated luminescence* (Sunna);

Dosimeter in Radiation Processing

Dosimeter system	Method of analysis	Dose Range	References
Fricke solution	UV – spectro- photometry	40 Gy – 400 Gy	ASTM E 1026 - 04
Ethanol-mono- chlorobenzene	Titration, or HF oscillometry	400 Gy – 80 kGy	ISO/ASTM 51538
Alanine	EPR	1 Gy – 100 kGy	ISO/ASTM 51607
Perspex systems (PMMA)	VIS - spectro- photometry	0.1 – 100 kGy	ISO/ASTM 51276
FWT – 60 film	VIS - spectro- photometry	0.5 kGy – 200 kGy	ISO/ASTM 51275
B3 film	VIS - spectro- photometry	3 kGy – 100 kGy (1 kGy by GEX)	ISO/ASTM 51275
Cellulose triacetate	UV – spectro- photometry	10 kGy – 300 kGy	ISO/ASTM 51650
Calorimetry	Resistance/ temperature	1.5 kGy – 50 kGy	ISO/ASTM 51631

Dosimeter in Radiation Processing

Dosimeter	Measurement time after irr.	Humidity
Alanine	24 hours	yes
Dichromate	24 hours	no
Ceric-cerous	immediately	no
ECB	immediately	no
Calorimeters	immediately	no
Perspex	24 hours	yes
FWT-60	5 min/60 °C	yes
B3	15 min/60 °C	yes
Sunna	20 min/70 °C	no

Dosimetry System

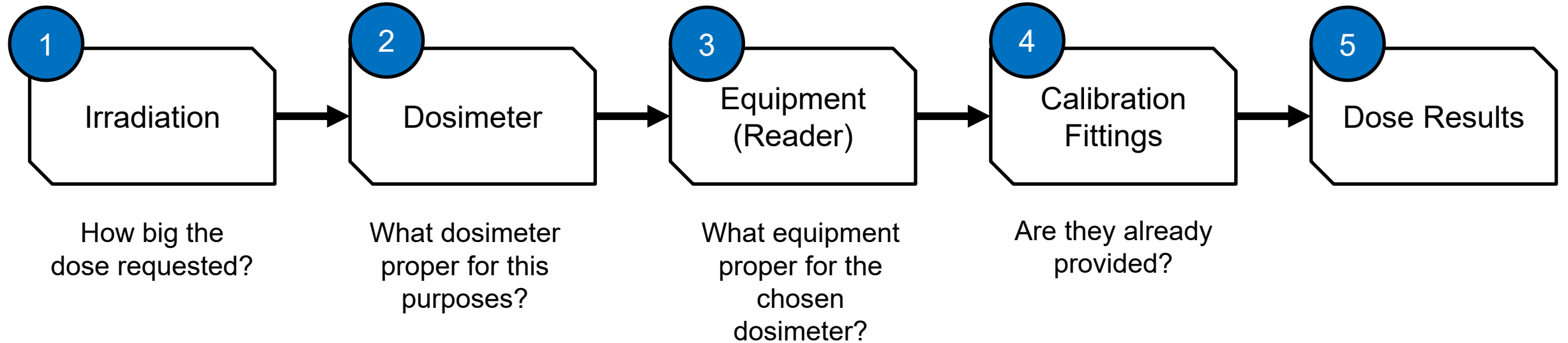

Dosimetry System: Alanine Dosimeter

INTERNATIONAL
STANDARD

ISO/ASTM
51607

Practice for use of an alanine-EPR dosimetry system

The estimate of the expanded uncertainty achievable with measurements made using alanine-EPR as a routine dosimetry system is typically of the order of 4–6 % for a coverage factor $k = 2$

1.4 This practice covers alanine-EPR dosimetry systems for dose measurements under the following conditions:

1.4.1 The absorbed dose range is between 1 and 1.5×10^5 Gy.

1.4.2 The absorbed dose rate is up to 10^2 Gy s^{-1} for continuous radiation fields and up to 3×10^{10} Gy s^{-1} for pulsed radiation fields (1-4).³

1.4.3 The radiation energy for photons and electrons is between 0.1 and 30 MeV (1, 2, 5-8).

1.4.4 The irradiation temperature is between -78 °C and $+70$ °C (2, 9-12).



Alanine
Dosimeter

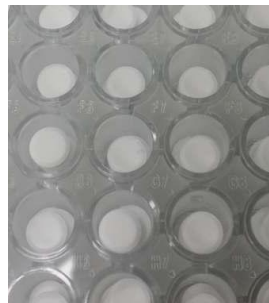

Change response of
alanine (and the color
when irradiated with
higher dose)



ESR Read the
alanine's response

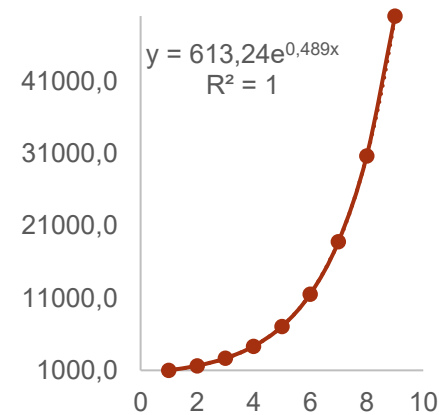

Conversion Absorbance
Specific to Absorbed Dose

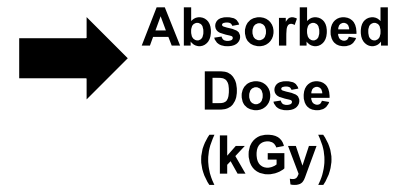

Dosimetry System: PMMA Dosimeter

INTERNATIONAL
STANDARD

ISO/ASTM
51276

Practice for use of a polymethylmethacrylate dosimetry system

The estimate of the expanded uncertainty achievable with measurements made using PMMA as a routine dosimetry system is typically of the order of 6 % for a coverage factor $k = 2$

1.2 This practice covers systems that permit absorbed dose measurements under the following conditions:

1.2.1 the absorbed dose range is 0.1 to 100 kGy.

1.2.2 the absorbed dose rate is 1×10^{-2} to 1×10^7 Gy·s⁻¹.

1.2.3 the radiation energy range for photons is 0.1 to 50 MeV, and for electrons 3 to 50 MeV.

1.2.4 the irradiation temperature is -78 to +50°C.

Type	Recommended Dose Range	Recommended Read-Out Wavelength
Red 4034	5 to 50 Kilograys (kGy)	640 nm
Amber 3042	1 to 30 kGy	603 nm or 651 nm

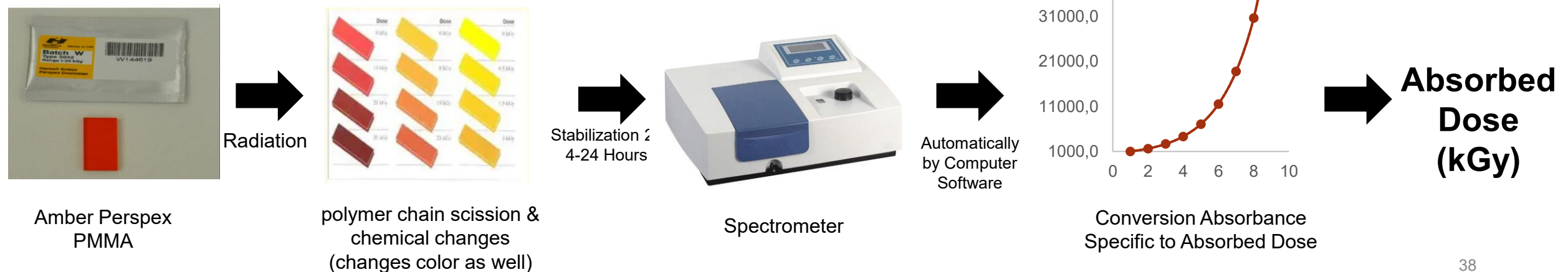

Dosimetry System: B3 Film

INTERNATIONAL
STANDARD

ISO/ASTM
51275

Practice for use of a radiochromic film dosimetry system

Dosimeter Type	Nominal Thickness, μm	Analysis Wavelength, nm	Usable Dose Range, kGy
FWT-60	50	605, 600, or 510	5 to 100
B3	18	552 ± 2	<1.0 to >120
GAFCHROMIC (various models)	Depends on model	Depends on model	Depends on model

TABLE A1.2 Some suppliers of radiochromic film dosimeters

Type	Supplier Address
Far West Technology, Inc.	330 S Kellogg Ave Suite D Goleta, CA 93117 USA
GEX Corporation	7330 South Alton Way Suite 12i Centennial, CO 80112 USA

The estimate of the expanded uncertainty achievable is 6.0 % (k=2), 95 % level of confidence



B3 Film



Radiation



Change color of
B3 Film

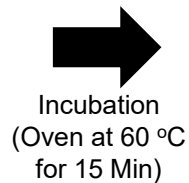

Incubation
(Oven at 60 °C
for 15 Min)

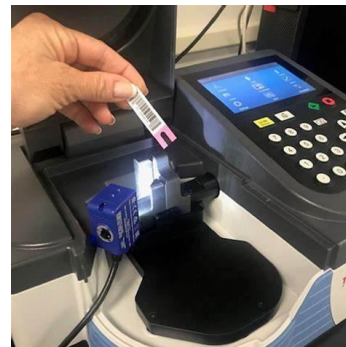

Spectrophotometer
read the absorbance



Automatically
by Computer
Software

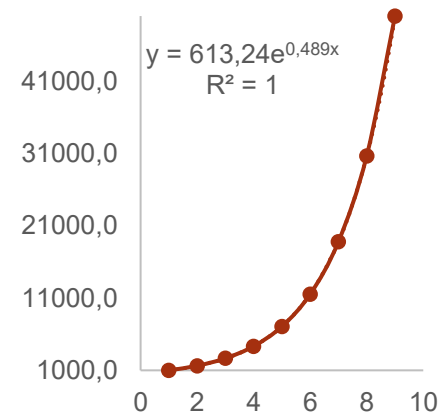

Conversion Absorbance
Specific to Absorbed Dose

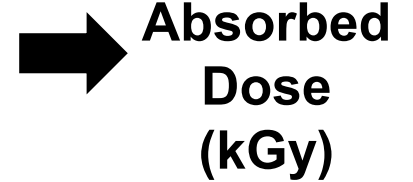

Absorbed
Dose
(kGy)

Dosimetry System: CTA Film

INTERNATIONAL
STANDARD

ISO/ASTM
51650

Practice for use of a cellulose triacetate dosimetry system

The estimate of the expanded uncertainty achievable is 6.0 – 8.0 %
(k=2), 95 % level of confidence

The CTA dosimetry system provides a means for measuring absorbed dose based on a change in **optical absorbance** in the CTA dosimeter following exposure to ionizing radiation



CTA Film

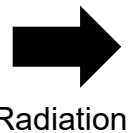

Change optical
absorbance

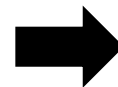

Spectrophotometer read the
absorbance.



Automatically
by Computer
Software

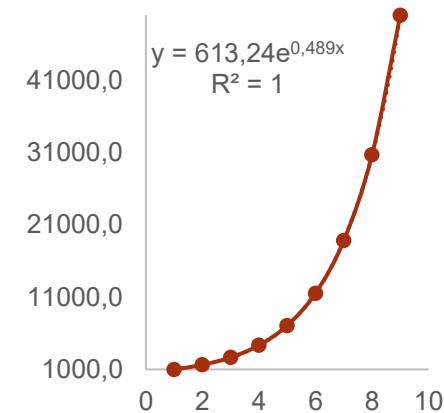

Mathematical Fitting



**Absorbed
Dose
(kGy)**

Wavelengths 280 nm for FTR-125

Dosimetry System: CTA Film

Metode 1: Rumus perhitungan dari Pabrikan

Rumus konversi dosis serap untuk CTA film dosimeter dituliskan sebagai berikut (Dokumen NHV)

$$D_{CTA} = \frac{\Delta OD}{K} \times \frac{0.125}{t} \times f \text{ (kGy)}$$

D_{CTA} dosis serap yang terukur dengan CTA film (kGy)

ΔOD peningkatan nilai absorbansi akibat iradiasi (irradiated – unirradiated)

K koefisien koreksi CTA (peningkatan absorbansi per 1 Mrad ≈ 0.0063 (kGy) $^{-1}$ untuk FTR-125-0922)

t ketebalan film CTA (mm), standar 0.125 mm

f faktor koreksi waktu absorbansi setelah iradiasi (umumnya $f = 1.0$ bila dibaca 1–3 jam pasca iradiasi)

Misal hasil ukur:

- $\Delta OD = 0.35$
- $t = 0.125$ mm (standar)
- $K = 0.0063$ (kGy) $^{-1}$
- dibaca 1–3 jam $\rightarrow f = 1.0$

$$D = \frac{0.35}{0.0063} \times \frac{0.125}{0.125} \times 1.0 \approx 55.6 \text{ kGy}$$

Metode 2: Kurva Kalibrasi response CTA dengan Dosis

Practical Aspects and Applications of Electron Beam Irradiation, 2011: 17-41
ISBN: 978-81-7895-541-4 Editors: Monica R. Nemtanu and Mirela Brasoveanu

2. Determination of absorbed dose distribution in technological accelerated electron beam treatments

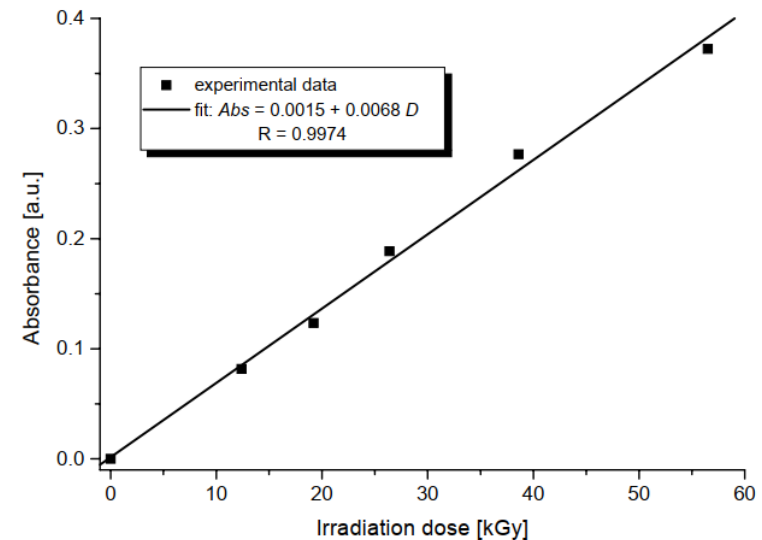

- CTA film menunjukkan respon linier terhadap dosis elektron/gamma di rentang uji (0–60 kGy).
- Semakin tinggi dosis, semakin besar absorbansi akibat degradasi ikatan kimia di polimer CTA.
- Kurva ini merupakan kurva kalibrasi spesifik untuk batch film & kondisi iradiasi tertentu (energi elektron, laju dosis, kondisi lingkungan).

Dosimetry System: CTA Film

Metode 1: Rumus perhitungan dari Pabrikan

$$D_{CTA} = \frac{\Delta OD}{K} \times \frac{0.125}{t} \times f \quad (\text{kGy})$$

Jika $t = 0.125$ mm dan $f = 1$, maka rumus pabrik mereduksi menjadi:

$$D \approx \frac{\Delta OD}{K}$$

Metode 2: Kurva Kalibrasi response CTA dengan Dosis

$$\text{Abs} = a + b D, \quad a = 0.0015, \quad b = 0.0068 \left[\frac{\text{Abs}}{\text{kGy}} \right], \quad R = 0.9974$$

$$\Rightarrow D = \frac{\text{Abs} - a}{b}$$

Sedangkan dari kurva:

$$D = \frac{\text{Abs} - a}{b} \approx \frac{\Delta OD}{b} \quad (\text{jika } a \approx 0)$$

Jadi $b \equiv K$ untuk kondisi standar.

Dari kurva kita tau bahwa:

$$b = 0.0068 \text{ Abs/kGy} \Rightarrow 1/b \approx 147 \text{ kGy/Abs.}$$

Rumus pabrik contoh menyebut $K \approx 0.0063$, perbedaan kecil ini wajar (batch, Panjang gelombang λ , suhu/kelembapan, laju dosis).



Influence Factor: Instrument/Equipment

- ❑ All measurement equipment must be calibrated and be traceable to national standards, include equipment. E.g. spectrophotometer
- ❑ Certain measurement equipment cannot be calibrated (e.g. signal amplitude from an EPR spectrometer) therefore
- ❑ The stability of the equipment has to be demonstrated by the use of measurement standards (e.g. stable EPR spin standards).
- *Spectrophotometer:*
absorbance and wavelength scale with calibrated optical filters;
- *Thickness gauge:*
calibrated gauge blocks;
- *Thermometers:*
calibrated thermometers;
- *Resistance measurement (Ohm-meter for calorimeters):*
calibrated reference resistor;

Influence Factor: Instrument/Equipment

Irradiation conditions are different from calibration conditions:

Temperature, dose rate, relative humidity, energy spectrum, irradiation geometry, etc.

Storage conditions:

before and after irradiation; (*apakah ada dry cabinet di fasilitas?*)

Instrumental errors:

absorbance and wavelength scale, scattered light, transfer of calibration curve from one instrument to another one, etc.

(*apakah instrument disimpan pada ruang dengan suhu yang dijaga di fasilitas?*)

Pit Stop

- Sebutkan diagram blok sistem dosimetri!
- Sebutkan dosimeter yang dipakai beserta rentang dan cara baca responnya (masing-masing fasilitas terkait)
- Apa itu alanine dosimeter dan bagaimana cara penggunaannya!

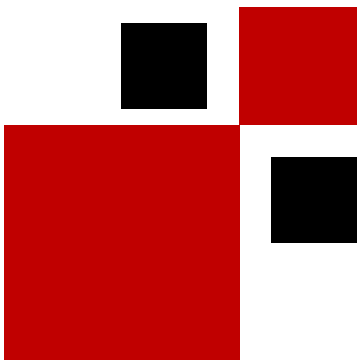



3

Kalibrasi dan Ketertelusuran



Dosis itu **dihitung, bukan diukur!**

Calibration

What Are the Important Things About Dosimetry

- Calibration
- Traceability
- Uncertainty Measurement
- Selection Criteria of dosimeter
- Influence Factor

IMPORTANT References!

- ISO/ASTM 51649:2015** : Practice for dosimetry in an electron beam facility for radiation processing at energies between 300 keV and 25 MeV
- ISO/ASTM 51261:2013** : Practice for calibration of routine dosimetry systems for radiation processing
- ISO/ASTM 51707:2015** : Guide for estimation of measurement uncertainty in dosimetry for radiation processing
- NPL. 2009** : Guidelines for the Calibration of Routine Dosimetry Systems for use in Radiation Processing.

Calibration

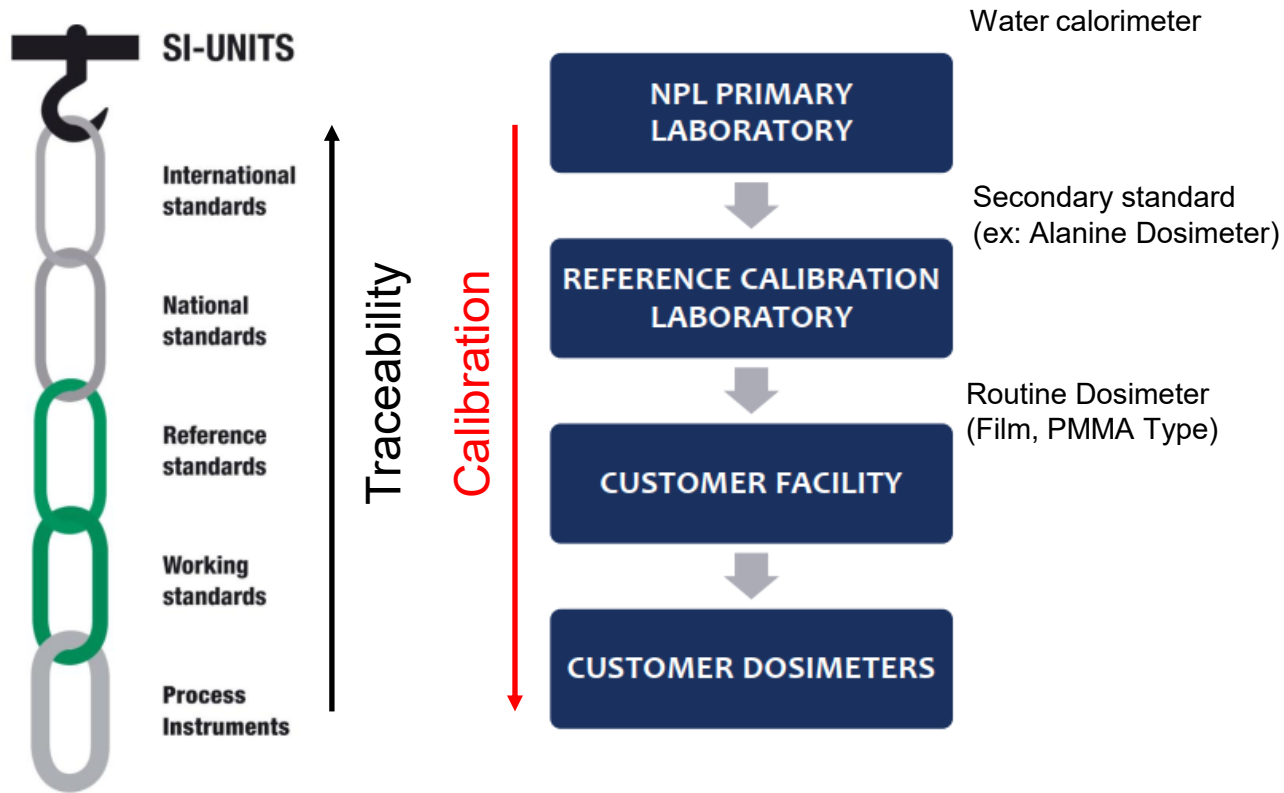

ISO/ASTM 51261:2013

Calibration (3.1.2) Establishes, under specified conditions, the relationship between the value of a quantity by a measurement system or the value through a reference material

Note:

1. Di Indonesia **BELUM ADA** laboratorium kalibrasi untuk level industri (high-dose) – ISO 17025
2. **BUKTI KALIBRASI** adalah sertifikat kalibrasi yang tercantum hasil kalibrasi dan ketidakpastian pengukurannya

Calibration

Reference (Primary and Secondary): standard systems (type I) used to calibrate dosimeters for routine use, therefore high metrological qualities, low uncertainty and traceability to appropriate national or international standards are needed.

$U_c \pm 3 \% (k = 2);$

Routine systems: Used for routine absorbed dose measurements (i.e. dose mapping and process monitoring). Traceability to national or international standards is needed.

$U_c \pm 5 \% (k = 2);$

Calibration

Basis of the estimates of absorbed dose to water at the various laboratories. Laboratory

Laboratory	Standard of absorbed dose to water in ^{60}Co reference radiotherapy field	Transfer to high-dose irradiator	Nominal dose rate / Gy s^{-1}	u_{lab} / %	Reference
BIPM	Primary standard ionization chamber	- ^a	0.007	0.31	[7]
CMI-IIR	Secondary standard ionization chamber ^b	Ionization chamber	0.36	2.2	[8]
ENEA-INMRI	Graphite calorimeter + thick-walled ionization chamber	Dichromate dosimeter via Fricke dosimeter in calibration irradiator	1.2	1.9	[9, 10]
LNE-LNHB	Graphite calorimeter + ionization chamber and Fricke dosimeter	Alanine dosimeter	2.7	0.9	[11]
NIM	Fricke dosimeter	- ^a	0.17	1.4	[12]
NIST	Water calorimeter	Alanine dosimeter	3.1 ^c	0.6	[3, 4]
NPL	Graphite calorimeter + scaling theorem	Alanine dosimeter	2.2	1.1	[5, 6]
Risø-HDRL	-	Alanine dosimeter ^d	1.8	1.4	[13]
VNIIFTRI	-	Polystyrene calorimeter ^e	2.4	0.7	[14, 15]

Highlight:

Realisasi besaran dosis serap di bidang fisika dan industri itu sama

Reference:

Supplementary comparison CCRI(I)-S3 of standards for absorbed dose to water in ^{60}Co gamma radiation at radiation processing dose levels

Primary Standard: Water Calorimeter

INSTITUTE OF PHYSICS PUBLISHING
Metrologia 43 (2006) 259–272

METROLOGIA
doi:10.1088/0026-1394/43/3/008

The PTB water calorimeter for the absolute determination of absorbed dose to water in ^{60}Co radiation

Achim Krauss

Physikalisch-Technische Bundesanstalt, Braunschweig, Germany

Received 2 February 2006

Published 9 May 2006

Online at stacks.iop.org/Met/43/259



Figure 1. The PTB water calorimeter (centre of the picture) in front of the ^{60}Co radiation facility (left side). Shown is the calorimeter's outer container with the radiation entrance area (dark square). The coolers for maintaining the operating temperature of 4°C and some of the associated electronics can be seen on the right side of the picture.

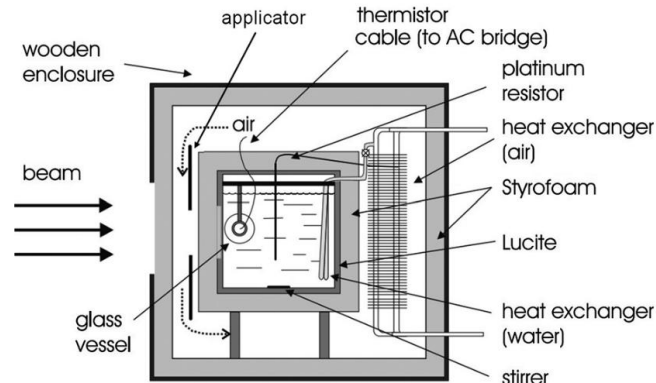

Fig. 1. A schematic of the NRC water calorimeter enclosure and set-up. Image not to scale.

Water Calorimetry

Absorbed dose to medium D_w ,

$$D_w = c_{w,p} \Delta T_m \frac{1}{1 - k_{HD}} \cdot \sum_{k=i} k_i \quad (3)$$

where, c_m : the specific heat capacity of medium*,
 ΔT_m : the measured temperature rise.
 k_{HD} : heat defect (degree of energy-conversion into the other forms than heat)
 k_i : corrections for heat transfer, perturbation, non-uniformity of the beams, water density, etc.

*Hammond C. **CRC Handbook of Chemistry and Physics, 2015–2016.** Boca Raton, FL: CRC Press; 2016.

Role as Primary Standard

- Considered a **primary standard dosimeter** because it measures dose directly from fundamental quantities (temperature, energy, mass).
- Provides the reference for calibration of secondary dosimeters (ionization chambers).

Calibration: Technical Aspect

- Determine **RELATIONSHIP** between response of a dosimeter and absorbed dose.
- The aim of the calibration is to ensure that dose measurements can be related to accepted standards.
- through a series of known steps, each with a defined level of uncertainty, i.e. to ensure traceability.

Regulatory standards, such as ISO 11137, impose specific requirements:

“Dosimetry used in the development, validation and routine control of the sterilization process **shall have measurement traceability** to national or international standards and shall have a known level of uncertainty.” (4.3.4)

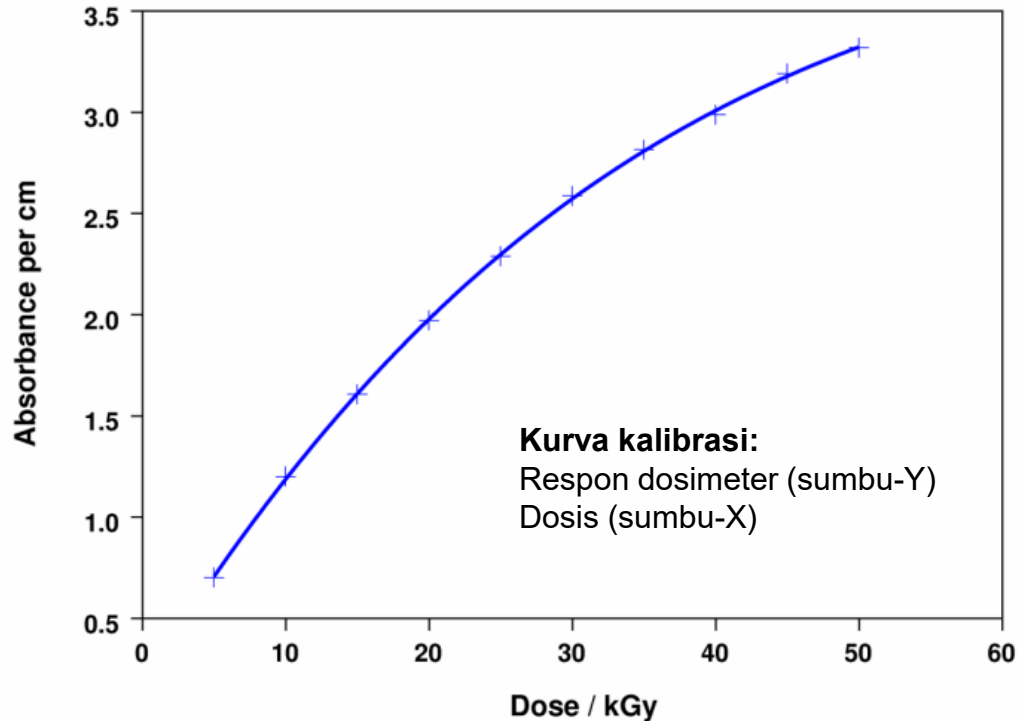

Best Practice!

DOSIS ITU TIDAK DIUKUR, NAMUN DIHITUNG.

Yang kita ukur adalah respon dosimeter

Calibration: Laboratory vs In-plant Calibration

Laboratory Calibration (*in-our-calibration laboratory*)

- ❑ Irradiation of dosimeters in the reference radiation field of a calibration laboratory (or of an in-house calibration facility) followed by “**calibration verification**” in the irradiation plant.
- ✓ **Advantages**
 - easy to obtain full dose range;
 - irradiation to accurately known doses under controlled and documented conditions;
- ✓ **Disadvantages:**
 - different conditions from real use (uncertainties);
 - transport of dosimeters (pre- and post-irradiation storage effects - uncertainties);

In-Plant Calibration (*in-your-plant*)

- ❑ Routine dosimeters are irradiated together with reference or transfer standard dosimeters in “**calibration phantoms**” in the irradiation plant.
- ✓ **Advantages**
 - calibration and production conditions are similar (environmental conditions);
- ✓ **Disadvantages:**
 - difficult to obtain full dose range in certain plants;
 - Use thermos label
- ✓ Care must be taken:
 - to ensure that all dosimeters irradiated together receive the same absorbed dose;

Calibration: Laboratory vs In-plant Calibration

Tahapan	Laboratory Calibration (in-our-calibration laboratory)	In-Plant Calibration (in-your-plant)
1. Pengiriman ke fasilitas user di awal	N/A	Yes
2. Iradiasi Dosimeter	Dikerjakan di laboratorium standar	Dosimeter dari lab. Standar diiradiasi Bersama dosimeter user di fasilitas user
3. Pembacaan Respon		Dosimeter user dibaca respon- nya di fasilitas user
4. Pembacaan Dosis		Dosimeter lab dibaca dosisnya di laboratorium standar
5. Pengiriman ke laboratorium standar	N/A	Yes
6. Pengiriman ke fasilitas user di akhir	Yes	N/A



Alanine dosimeter sebagai dosimeter transfer



B3 film dosimeter

Calibration

LABORATORIUM STANDAR

Mengirim alanine sebagai dosimeter transfer

FASILITAS IRADIASI (di Indonesia)

Alanine dan dosimeter user (B3) diiradiasi bersama dengan menggunakan Phantom

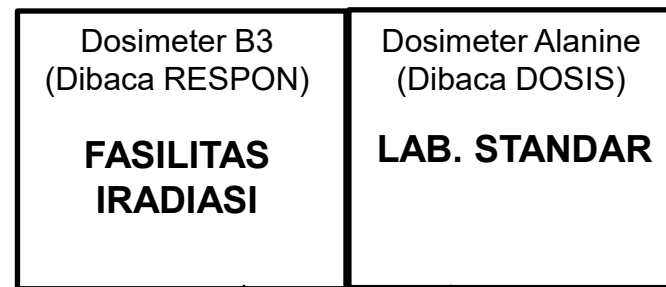

Kurva kalibrasi:
Respon dosimeter (sumbu-Y)
dan Dosis (sumbu-X)

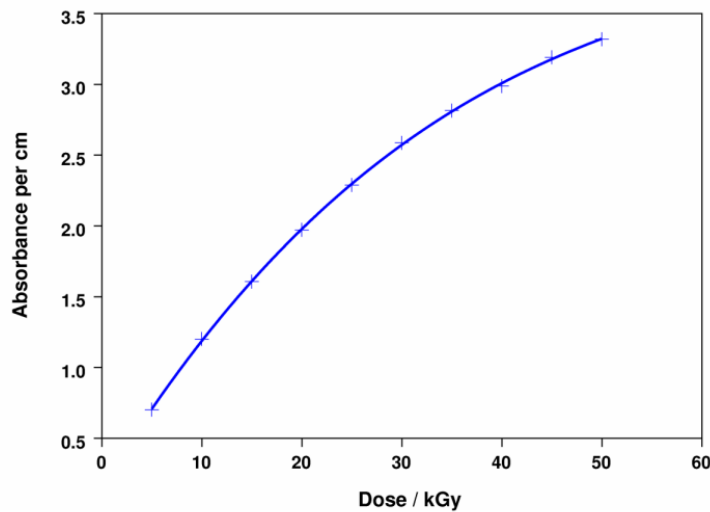

Kurva kalibrasi dosimeter

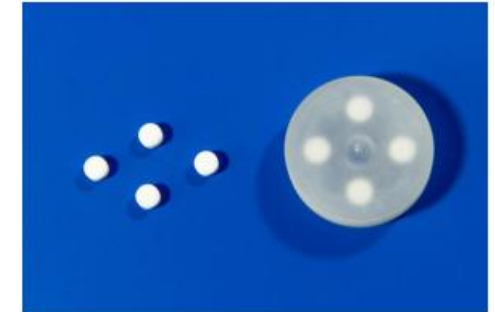

Alanine dosimeter sebagai dosimeter transfer



B3 film dosimeter

Verification

Why do we need calibration verification

1. Perbedaan kondisi lingkungan (suhu, laju dosis, dll.) antara iradiator kalibrasi dan pabrik industri dapat menyebabkan kesalahan sistematis.
2. Transportasi dosimeter antara iradiator kalibrasi dan pabrik industri juga dapat menimbulkan sumbangsih kesalahan.
3. Sumbangsih kesalahan ini dapat dideteksi dengan mengiradiasi dosimeter rutin bersama dosimeter referensi di pabrik industri – **Verifikasi Kalibrasi**.

Best practice

- I. Iradiasi dosimeter rutin bersamaan dosimeter referensi di fasilitas user
- II. Gunakan setidaknya tiga titik dosis dengan dua dosimeter referensi dan empat dosimeter rutin di setiap titik.
- III. Tentukan perbedaan antara pembacaan dosis dari dosimeter rutin dan dosimeter referensi.
- IV. Periksa hasil untuk melihat adanya perbedaan sistematis

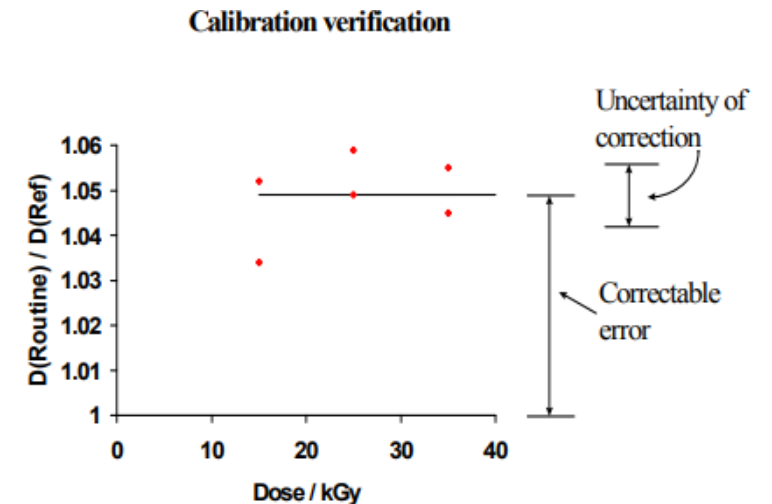

Calibration: Number of Decade Rules

Calibration over less than one decade of dose:
Use at least five dose points distributed arithmetically,
e.g. 10, 20, 30, 40, 50 kGy.

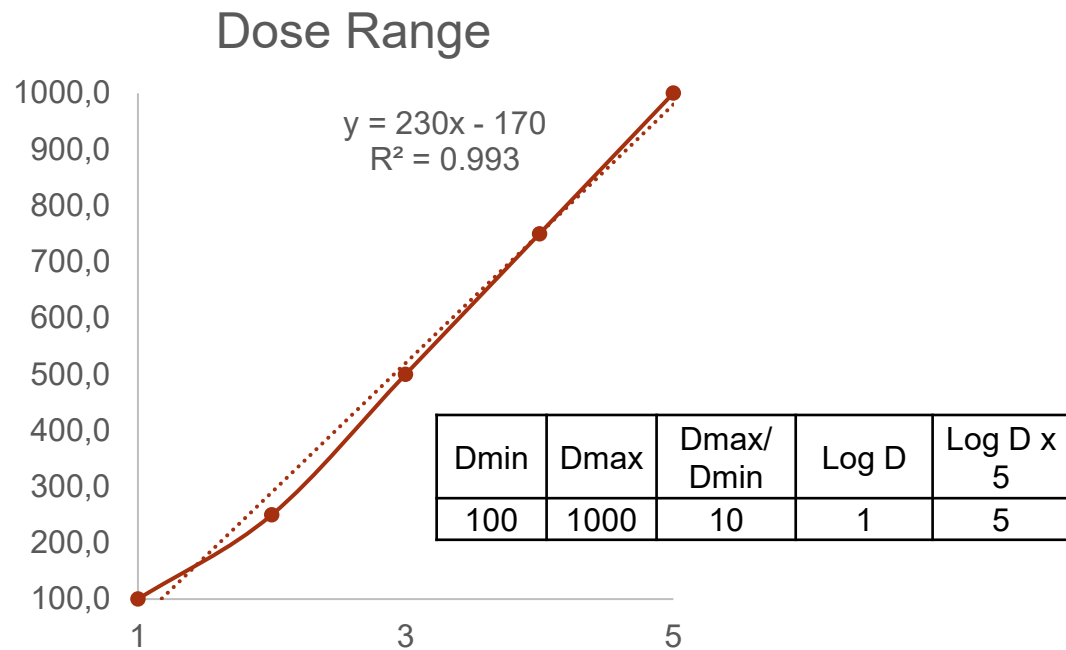

Calibration over more than one decade of dose:
Use at least five dose points per decade distributed
geometrically e.g. 1, 1.5, 2.3, 3.4 38, 58, 87 kGy.

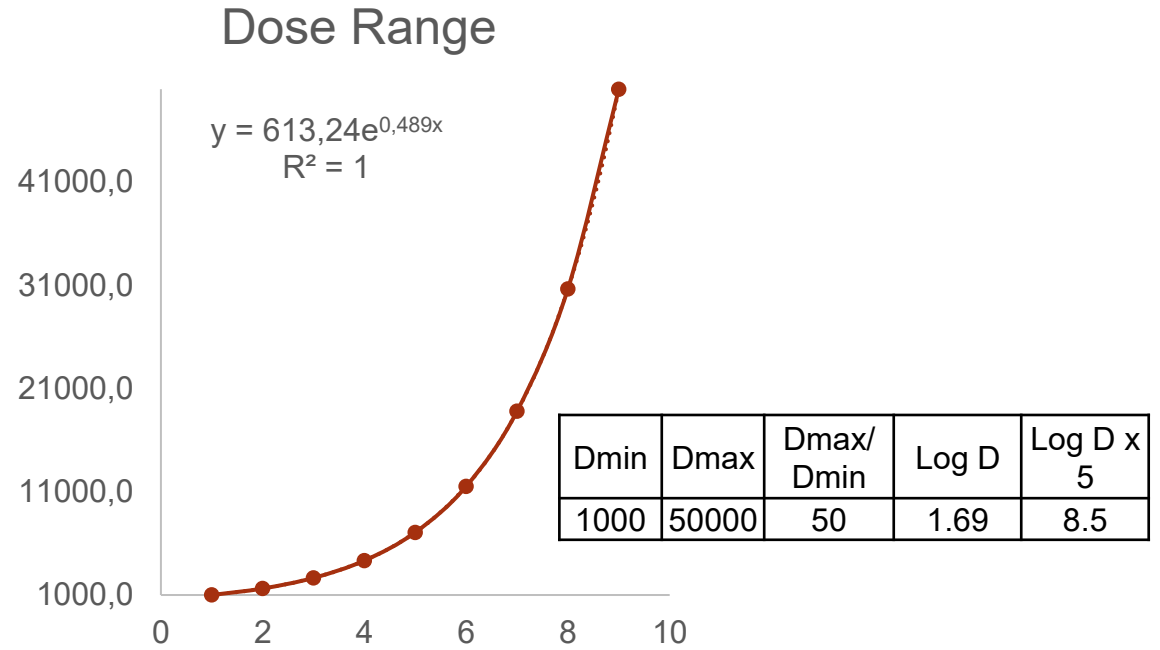

Use at least **four replicate dosimeters** at each dose point.

Calibration: Number of Decade Rules

Kapan kita butuh? Saat kita sedang akan request titik dosis untuk dikalibrasi di Lab. Standar

Pemilihan antara **distribusi aritmetika** atau **geometrika** dapat dijustifikasi menggunakan hubungan logaritmik antara dosis maksimum D_{max} dan D_{min} .

$$\text{Jumlah Dekade} = \log_{10} \left(\frac{D_{max}}{D_{min}} \right)$$

- ✓ Gunakan distribusi aritmetika jika

$$\log_{10} \left(\frac{D_{max}}{D_{min}} \right) < 1$$

- ✓ Gunakan distribusi geometrika jika

$$\log_{10} \left(\frac{D_{max}}{D_{min}} \right) \geq 1$$

Kriteria	Distribusi Aritmetika	Distribusi Geometrika
Rentang dosis	Jika $D_{max}/D_{min} < 10$	Jika $D_{max}/D_{min} \geq 10$
Polanya	Selisih tetap antar dosis	Rasio tetap antar dosis
Respons sistem	Linier terhadap dosis	Eksponensial atau logaritmik terhadap dosis
Contoh	10, 20, 30, 40, 50 kGy	1, 1.5, 2.3, 3.4, 5.3, 8.3, 13, 20, 31, 50, 79 kGy

Pit Stop

- Apakah kalibrasi bisa dilakukan oleh internal?
- Sebutkan perbedaan kalibrasi *in-plant* dan *in-lab*?
- Apa bukti sudah dilakukan kalibrasi?
- Jelaskan mekanisme perhitungan dosis dengan menggunakan dosimeter hingga keluar nilai dosisnya!

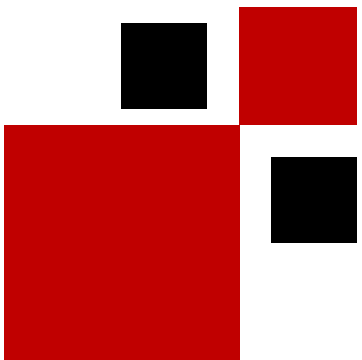



4

Ketidakpastian Pengukuran

Ketidakpastian Pengukuran (Uncertainty)

Metrologia

KEY COMPARISON

APMP Key comparison report of reference air kerma rate for HDR ^{192}Ir brachytherapy sources (BIPM KCDB: APMP.RI(I)-K8)

J Ishii, T Kurosawa, M Kato, P Toroi, W-H Chu, C-Y Yi, Y H Kim, Y M Seong, S A Ngcezu,

E Mainegra-Hing [Show full author list](#)

Published 21 October 2021 • © 2021 BIPM & IOP Publishing Ltd

[Metrologia](#), Volume 58, Number 1A

Citation J Ishii et al 2021 *Metrologia* 58 06020

DOI 10.1088/0026-1394/58/1A/06020

^aNational Metrology Institute of Japan, Tsukuba, Japan

^bInternational Atomic Energy Agency, Vienna, Austria

^cInstitute of Nuclear Energy Research, Longtan, Taiwan

^dKorea Research Institute of Standards and Science, Yusong, Korea

^eNational Metrology Institute of South Africa, Pretoria, South Africa

^fNational Research Council of Canada, Ottawa, Canada

^gMalaysian Nuclear Agency (Nuclear Malaysia), Kajang, Malaysia

^hNational Atomic Energy Agency (BATAN), Jakarta, Indonesia

Manakah hasil pengukuran yang **TERBAIK**?

Apakah hasil PTKMR BATAN itu **SALAH**?

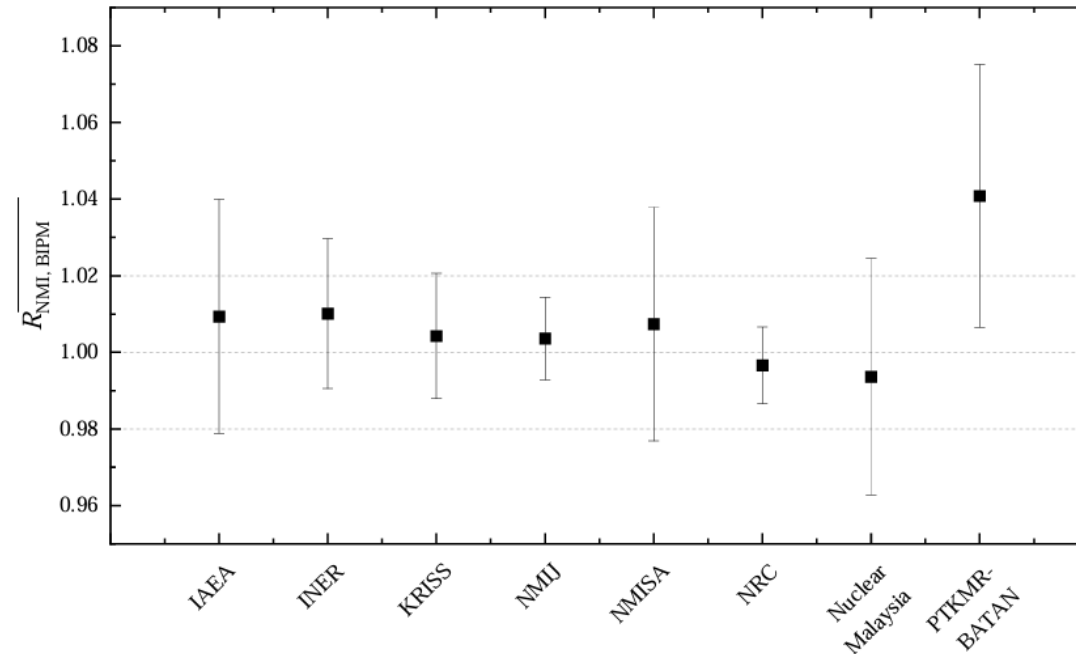

Penggunaan error bar dalam penampilan data statistik yang merepresentasikan **ketidakpastian pengukuran** sangatlah penting!

Ketidakpastian Pengukuran (Uncertainty)

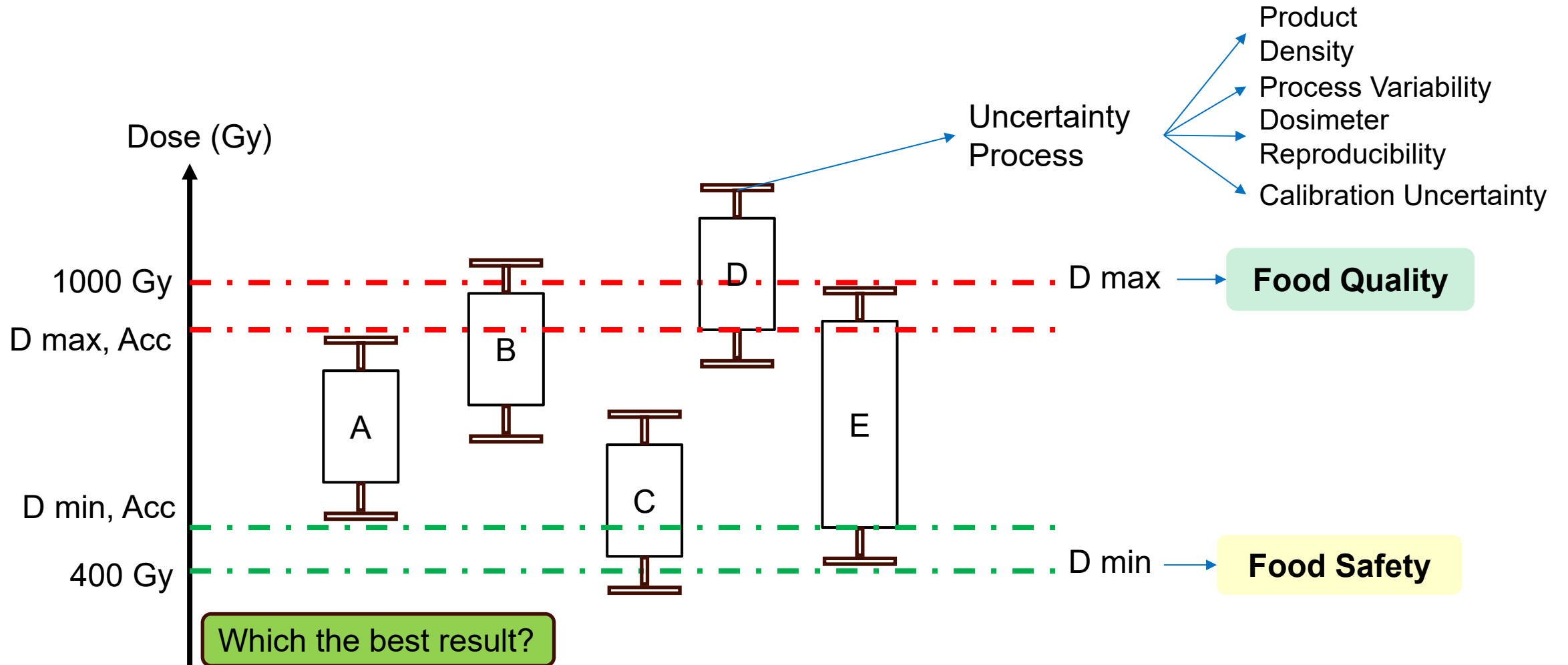

Ketidakpastian Pengukuran (Uncertainty)

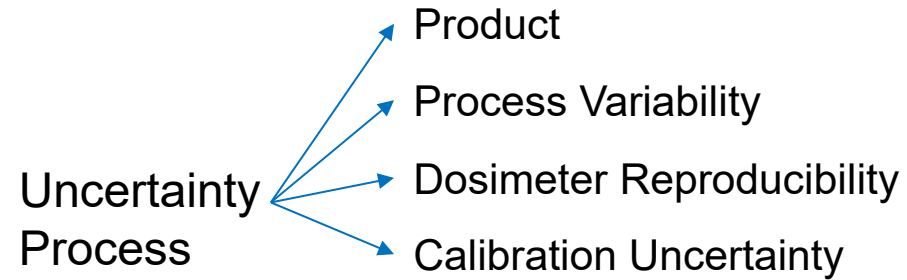
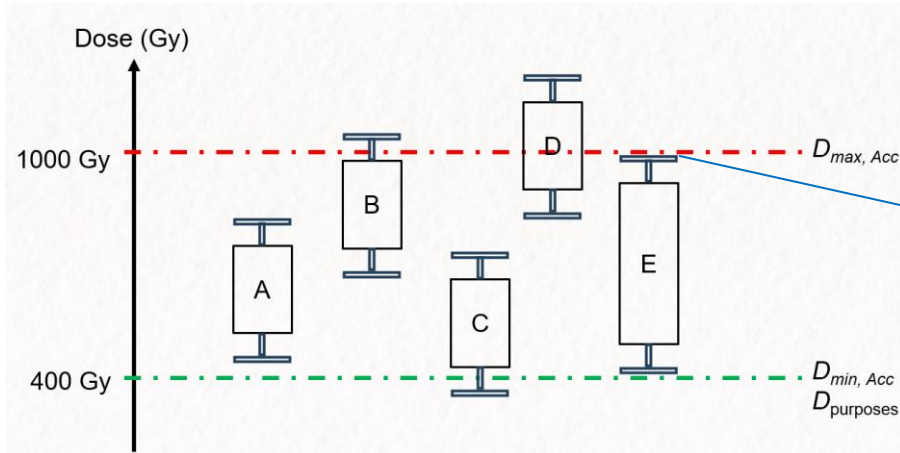

8.3.1 Absorbed Doses Required to Accomplish Specific Effects—Food irradiation specifications provided by the owner of the product should include minimum and maximum absorbed dose limits: a minimum necessary to ensure the intended effect, and a maximum to prevent product degradation. One or both of these limits may be prescribed by regulation for a given application. See, for example, FDA and

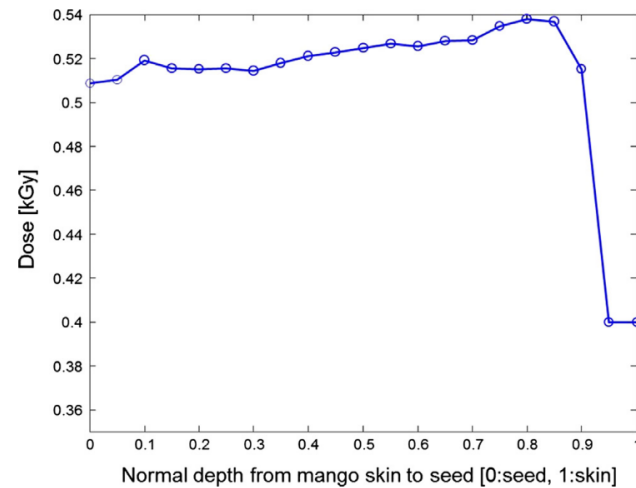
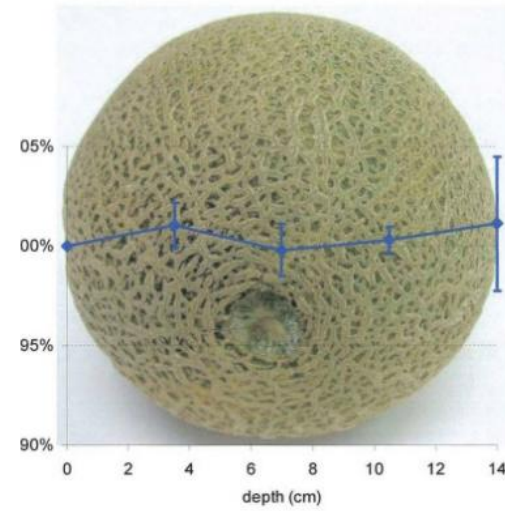
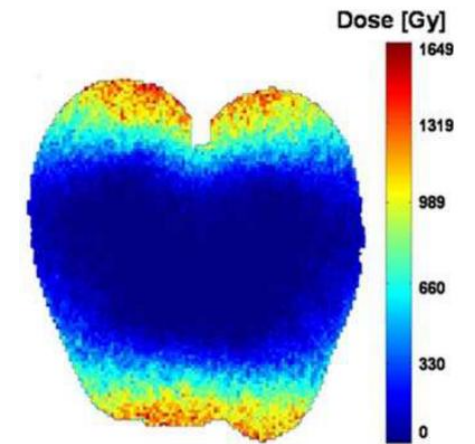

Fig. 4. Monte Carlo simulation of dose distribution in a mango from skin to seed with major axis beam direction.



Average of three dose profiles after double sided gamma irradiation REF. IAEA TRS No. 481 (2015)



(Jongsoo Kim, 2005) Distribusi dosis pada buah apel

Ketidakpastian Pengukuran (Uncertainty)

Process total uncertainty, from ISO 11137-4

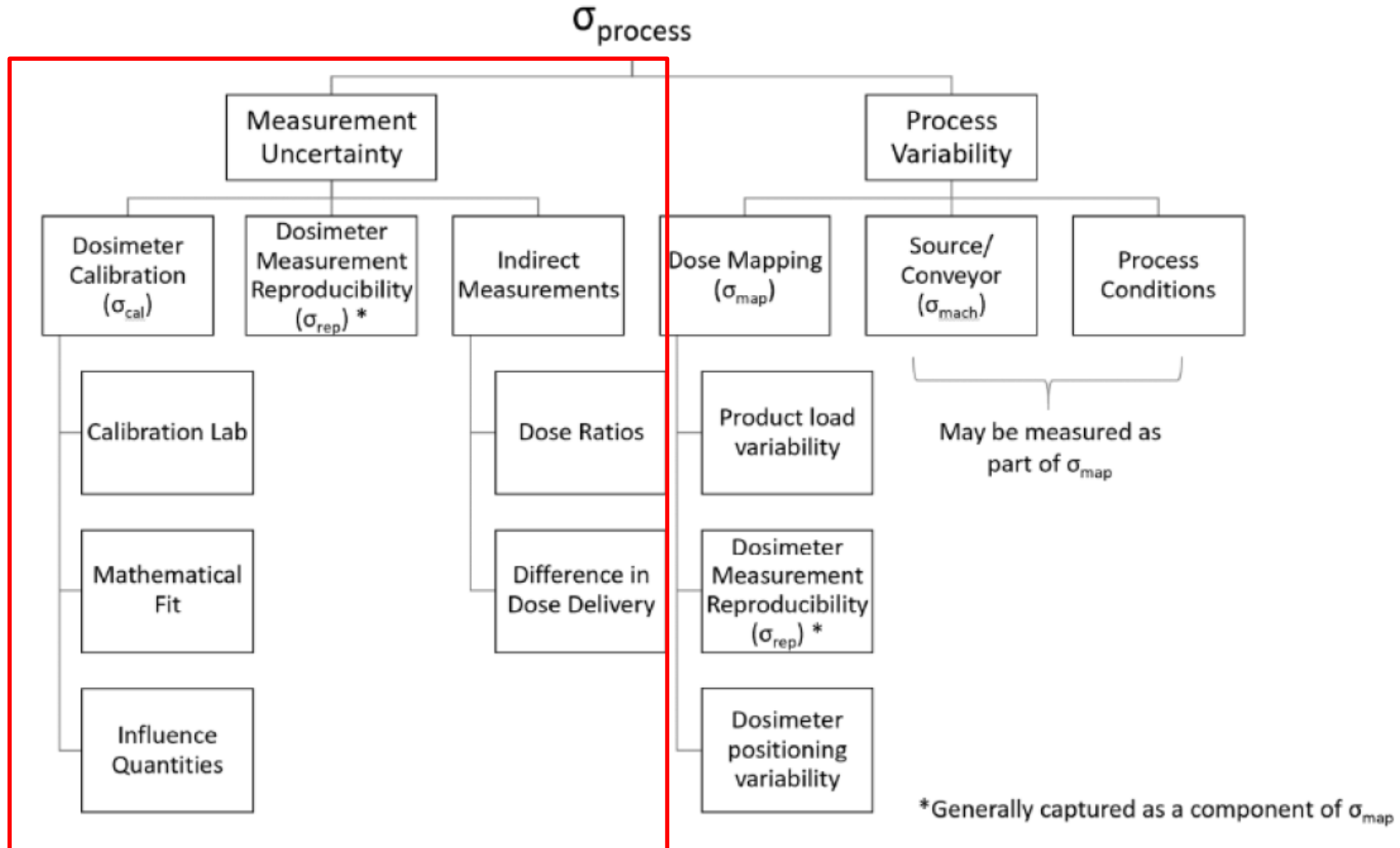

Ketidakpastian Pengukuran (**Uncertainty**)

The result of a (dose) measurement is only an approximation or estimate of the (dose) value and it is complete only when accompanied by a quantitative statement of **its uncertainty**:

Example: **Absorbed dose = 27.4 +/- 0.55 kGy**

Ketidakpastian Pengukuran (**Uncertainty**)

- ❑ The uncertainty of the result of a measurement consists of several components, which have to be investigated from calibration to routine use.
 - Types of uncertainties:

- ❑ Evaluated by statistical methods – A type (random)
 - (e.g. standard deviation of the mean) – related mainly to precision (i.e. reproducibility) of the dosimeter response.

- ❑ Evaluated by other means (based on scientific judgement, e.g. previous experimental data) – B type (non-random, systematic)
 - related mainly to calibration (accuracy).
 - Systematic errors e.g. instrumental errors (bandwidth, absorption peak or shoulder, calibration curve „transfer”), irradiation conditions different from calibration conditions;

- ❑ A and B can be combined if they do not depend on each other

Ketidakpastian Pengukuran (Uncertainty)

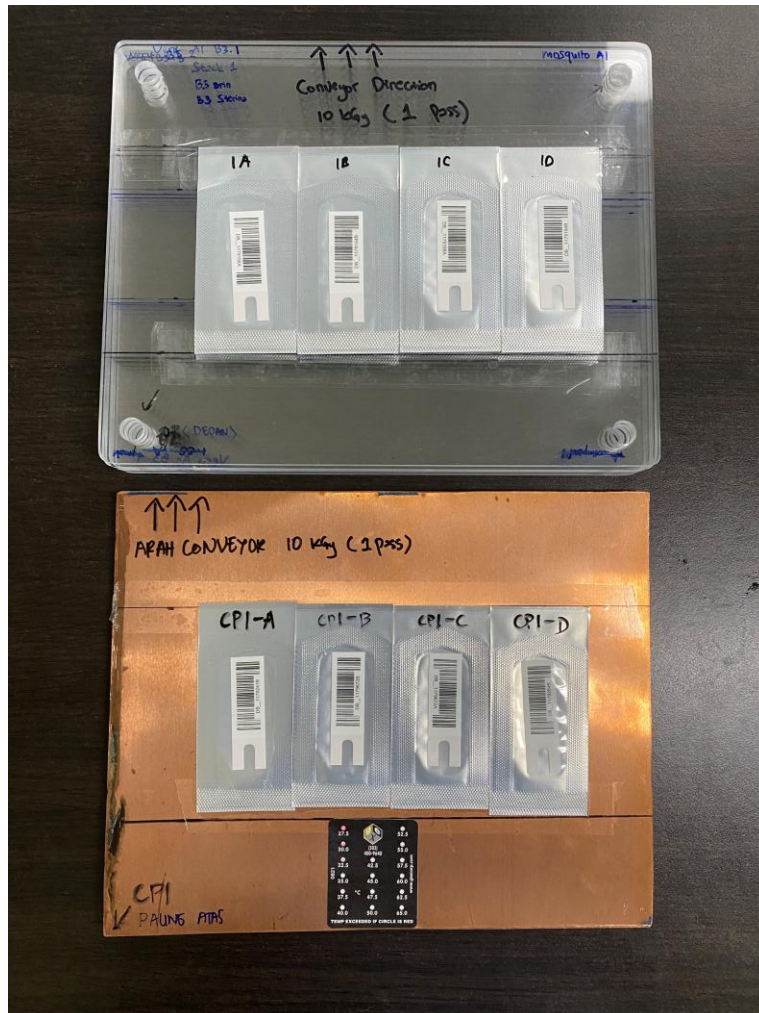

Contoh:

Reproducibility Positioning of dosimeter

- Penempatan pada tempat yang sama untuk setiap pengukuran
- 1 titik dosis, minimal menggunakan empat dosimeter

Ketidakpastian Pengukuran (Uncertainty)

- ❑ Uncertainties in preparing the calibration function
 - uncertainty in calibration doses;
 - uncertainty due to fit of calibration function;
 - uncertainty due to environmental influence factors.

- ❑ Uncertainty in use of dosimeters
 - uncertainty due to dosimeter-to-dosimeter scatter;
 - uncertainty due to variation in plant environmental conditions;
 - uncertainty due to instability of dosimeter reading;
 - uncertainty due to instability of instrumentation.

Ketidakpastian Pengukuran (Uncertainty)

Table A.5: NPL uncertainty budget

Component of uncertainty	Type A (%)	Type B (%)
Calibration of secondary standard ionisation chamber.		0.6
Use of chambers to calibrate alanine dosimeters in therapy-level ⁶⁰ Co beam*	0.3	
Transfer of alanine calibration from therapy-level beam to high dose irradiator beam	0.3	0.5
Use of high dose irradiators to irradiate customer dosimeters	0.7	
Timing		0.05
Combined standard uncertainty ($k=1$)	1.1	

* Theratron - NPL ⁶⁰Co therapy irradiator. Dose rate 0.9 Gy / min January 2019

Table A.4: NIST uncertainty budget

Component of uncertainty	Type A (%)	Type B (%)
Reference dose rate	0.37	0.56
Alanine response	0.60	0.15
Dose rate effect		0.10
Temperature correction		0.10
Calibration curve	0.5	0.10
Combined standard uncertainty ($k=1$)	1.05	

Source: Supplementary comparison CCRI(I)-S3 of standards for absorbed dose to water in ⁶⁰Co gamma radiation at radiation processing dose level

Ketidakpastian Pengukuran (Uncertainty)

Component of uncertainty	Value	Probability distribution	Divisor	Relative standard uncertainty	
				Type A	Type B
Calibration doses from laboratory certificate	2.6% ($k=2$)	Gaussian	2		1.3%
Fit of calibration function	0.5%	Gaussian	1	0.5%	
Correction of reference dosimeters for irradiation temperature	1.0%	Rectangular	$\sqrt{3}$		0.6%
Difference in dose to reference and calibration dosimeters	1.0%	Rectangular	$\sqrt{3}$		0.6%
Dosimeter-to-dosimeter scatter (reproducibility)	0.6%	Gaussian	1	0.6%	
Combined uncertainty				1.8%	
Expanded uncertainty ($k=2$)				3.6%	

Guidelines for the Calibration of Routine Dosimetry Systems for use in Radiation Processing (2009, NPL)

Ketidakpastian Pengukuran (Uncertainty)

❑ Analysis of dosimeters

- use of calibrated instrumentation
- time of analysis after irradiation (potential changes of dosimeter response after irradiation)

❑ Analysis of calibration data

- mean response and sample standard deviation
- calculation of coefficient of variation (std/mean)

❑ Preparation of calibration curve

- signal = $f(\text{dose})$
- evaluation of mathematical expression (e.g. calculation of "percentage residuals") to select best fit

Data Analysis

Best Practice for daily process

No	Dose Setting (kGy)	ID	Measured Dose (Gy)	Dose Average (kGy)	Deviasi (%) (measured/setting)	STD DEV	RSD (CV)
1	2	D1-1	2.200	1.995	-0.25%	0.164	0.082
		D1-2	1.800				
		D1-3	1.970				
		D1-4	2.010				
2	10	D2-1	10.030	9.908	-0.93%	0.189	0.019
		D2-2	9.700				
		D2-3	9.800				
		D2-4	10.100				
3	15	D3-1	14.700	15.03	0.17%	0.275	0.018
		D3-2	15.200				
		D3-3	15.300				
		D3-4	14.900				

- Satu titik dosis terdiri empat dosimeter
- Hasil yang dibaca adalah hasil nilai rata-rata dosis
- Perhatikan untuk deviasi antara dose setting dan measured dose



Application Dosimetry in Short

International Standards:

- ISO 14470:2011 Food irradiation — Requirements for the development, validation and routine control of the process of irradiation using ionizing radiation for the treatment of food *and many others ...*

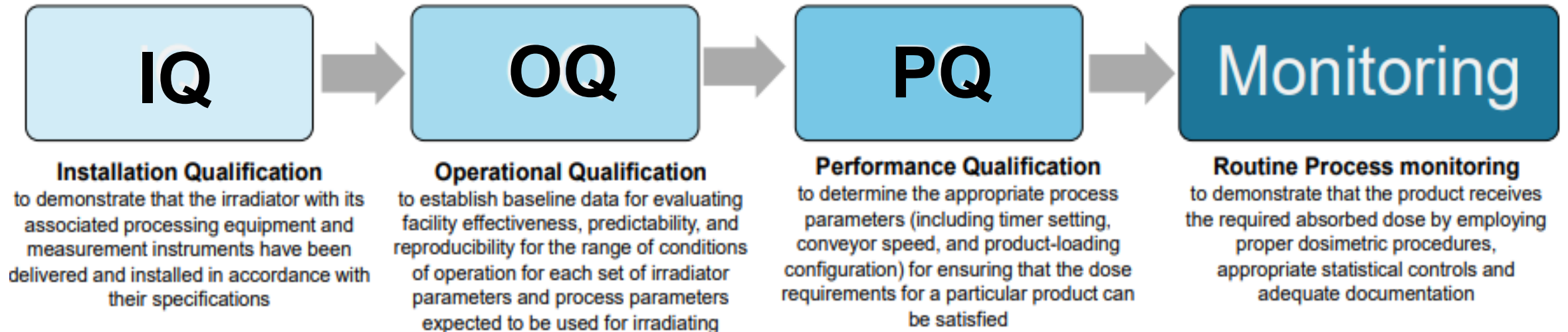

Aplikasi Dosimetri

- **Installation Qualification**

To demonstrate that irradiator has been supplied and installed in accordance with its specifications

- **Operational Qualification**

To demonstrate that the irradiator, as installed, is capable of operating and delivering appropriate doses within defined acceptance criteria (*characterize the radiation facility*)

- **Performance Qualification**

To determine the appropriated process parameters for ensuring that the dose requirement for a particular can satisfied (*dose distribution in irradiated products*)

- **Process Control**

To demonstrate that the product receives the required absorbed dose by employing proper dosimeter procedures, appropriate statistical control, and adequate documentations (*monitor the irradiation process*)

Medical Physics Field vs Industrial Field: **Treatment Planning**



Step1

CT image of the volume of interest

Input CT Image (DICOM)
in TPS

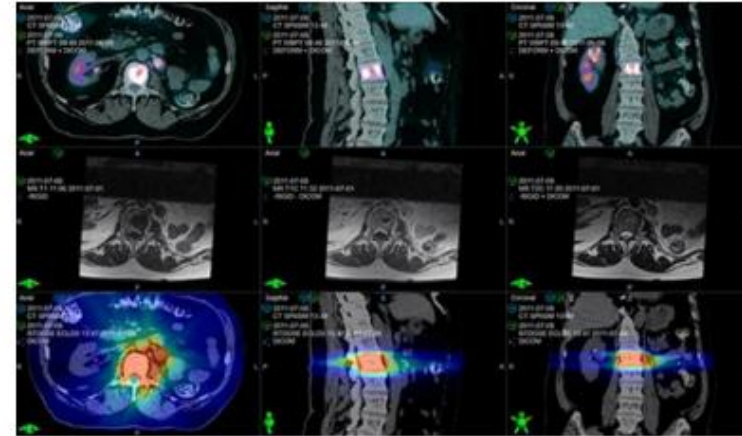

Step2

TPS → determine irradiation parameters



Step3

Irradiate the tumour according to
TPS defined protocol

Medical Physics Field vs Industrial Field: Treatment Planning

Tidak ada sistem TPS di Iradiasi Industri, melainkan melakukan *dose mapping* secara manual.

Dose Mapping



Irradiation Treatment

1. D_{minimum}
2. D_{maximum}
3. $D_{\text{reference}}$

$$D_{\text{reference}} = D_{\text{monitoring}}$$

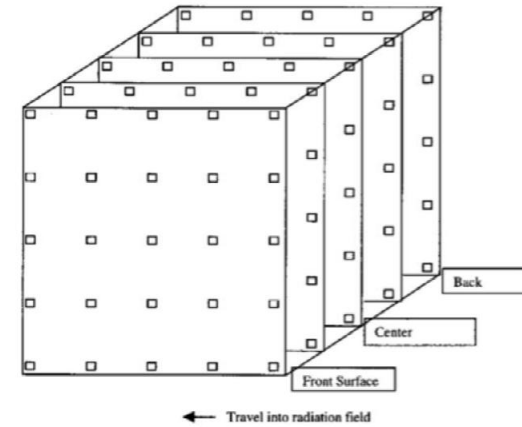

(ISO ASTM 51702:2014)

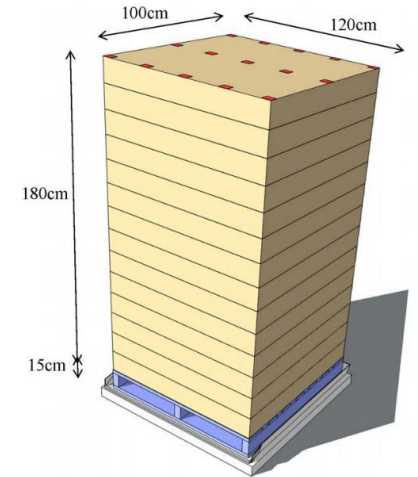

(IAEA, 2015)

Kotak-kotak kecil menggambarkan **dosimeter yang terpasang**



(Nguyen Trung Truc, 2021)

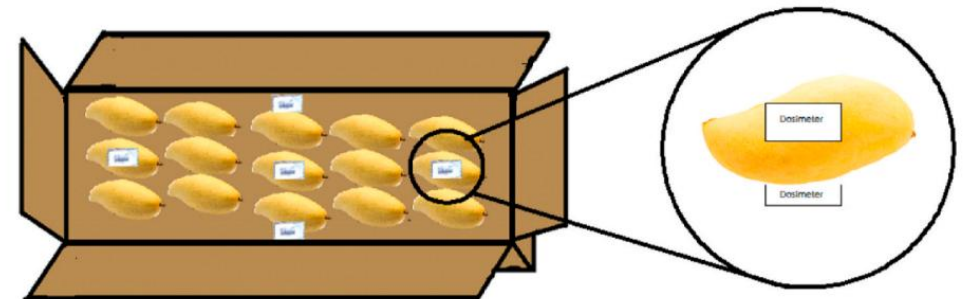

Medical Physics Field vs Industrial Field: Treatment Planning

Dose Mapping for medical devices



Organized loading



Unorganized loading



Medical Physics Field vs Industrial Field: Treatment Planning

Dose Mapping for phytosanitary irradiation

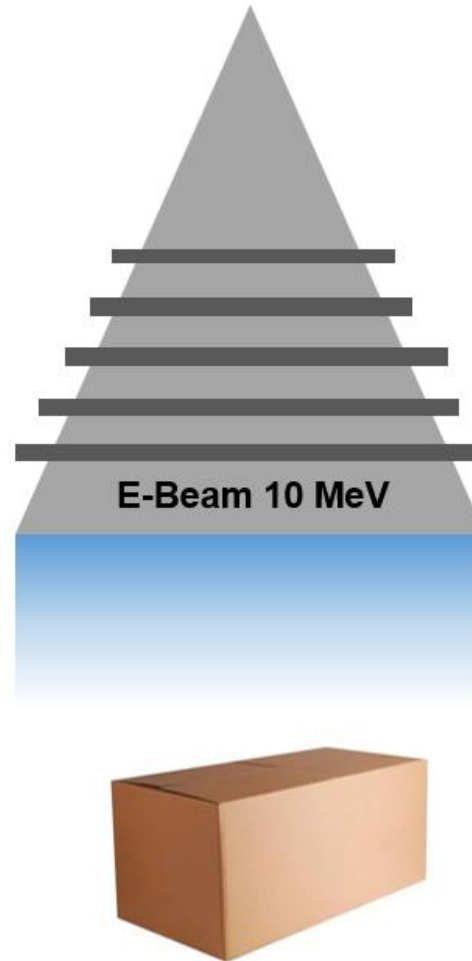

BOX

Dose at Box's surface = ~ 418 Gy

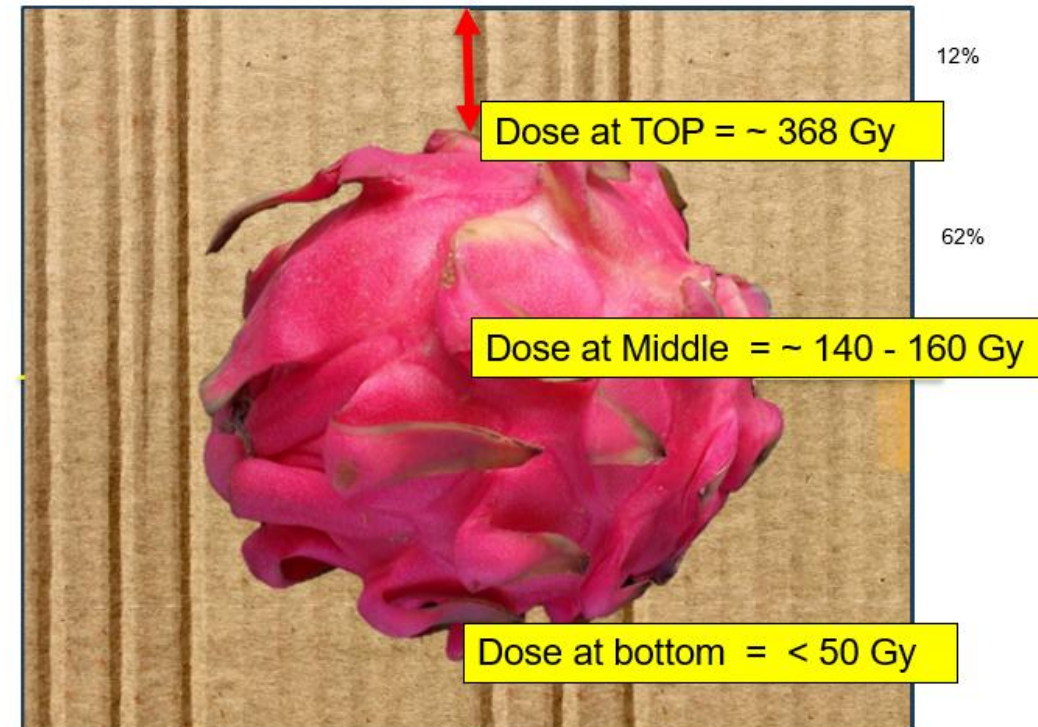

QUIZ

Ketik link berikut

joinmyquiz.com

Masukkan nomor

83 89 124

Scan QR berikut

Scan QR code

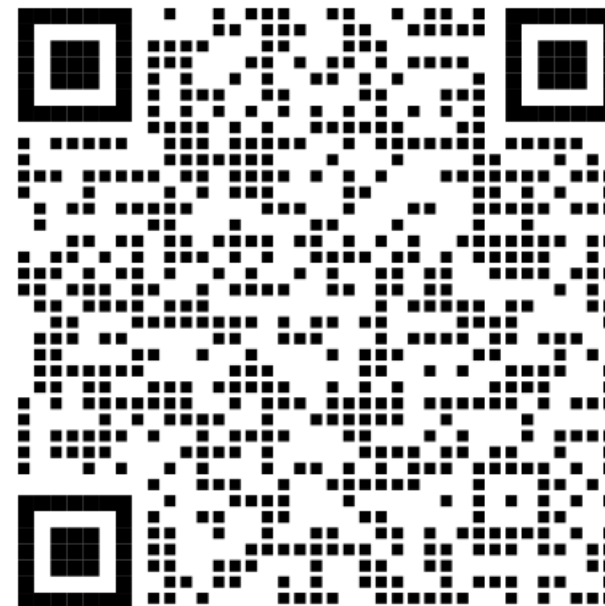

Rangkuman

1. Teori Dasar Dosimetri

- KERMA dan absorbed dose
- Fenomena build up dose

2. Kalibrasi dan Ketertelusuran

- Dosimetry standard sekunder
- Kalibrasi in-plant dan in-laboratory
- Aturan number of decade (untuk titik dosis kalibrasi)

Rangkuman

3. Faktor-Faktor yang mempengaruhi pengukuran

- Suhu
- Kelembaban
- Temperatur
- Post-irradiation time

4. Ketidakpastian pengukuran

- Ketidakpastian pengukuran dosimeter dan proses radiasi
- Ketidakpastian tipe A dan B



Dosimetry is like seasoning salad with **salt**.

A pinch brings out flavor, but too much ruins the dish.

*Radiation dose must be just right— dosimetry is how we '**measure the salt**' to keep the process balanced and effective.*

Terima Kasih

감사합니다!

Okky Agassy Firmansyah

PRTKMMN BRIN

081210698624

oafirmansyah@gmail.com

okky001@brin.go.id

