

Qualification For Gamma and EB Machine

Bimo Saputro

official.bimosaputro@gmail.com

bimo001@brin.go.id

+62813 1941 7800

Pelatihan Penyegaran Petugas Iradiator

Direktorat Pengembangan Kompetensi BRIN - 2025

PROFILE



- Bimo Saputro
- Sarjana – Fisika Nuklir, Politeknik Teknologi Nuklir Indonesia (STTN-BATAN) 2012-2016
- Magister – Fisika, Universitas Indonesia 2023-2024
- Honda Motor Ltd. 2016-2017
- BATAN 2018-2021
- BRIN 2021-Current
- Fellowship on Gamma Radiation Facility at Vinca, Belgrade, Serbia 2019
- Online Training Course by IAEA Expert (Andras Kovacs, Hungary) on Radiation Dosimetry 2020
- Fellowship on Radiation Dosimetry at Aerial CRT, Strasbourg, France 2021
- Scientific Visit on Radiation Processing Technology at KAERI, Jeungup, Korea 2022
- Workshop Accelerating the Adoption of eBeam/X-ray technologies in Asia and the Pacific Daejeon, Korea 2022
- Regional Project on eBeam Application in Asia-Pacific. Daejeon, Korea 2023
- IAEA Research Project on Dosimetry at Aerial CRT Strasbourg, France 2023
- Speaker on International Conference on Applications of Radiation Science and Technology at IAEA Vienna, Austria 2022
- Speaker on International Meeting on Radiation Processing IMRP at TINT Bangkok, Thailand 2022
- Speaker on International Meeting on Radiation Processing IMRP at San Jose, Costa Rica 2024
- Speaker on Regional Workshop on eBeam Application at Ho Chi Min, Vietnam 2024

1. What do you expect from an operation?

2. Is the Operation related to IQ OQ and PQ?

- Installation Qualification
- Operational Qualification
- Performance Qualification

HIGHLIGHT AGENDA

1. Installation Qualification

2. Operational Qualification

3. Performance Qualification

4. Process Control

Calibration

ISO/ASTM 51261:2013

Calibration (3.1.2) Establishes, under specified conditions, the relationship between the value of a quantity by a measurement system or the value through a reference material

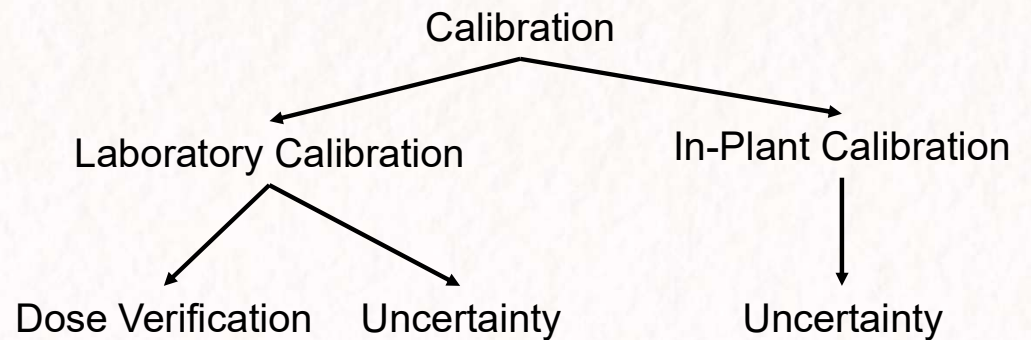
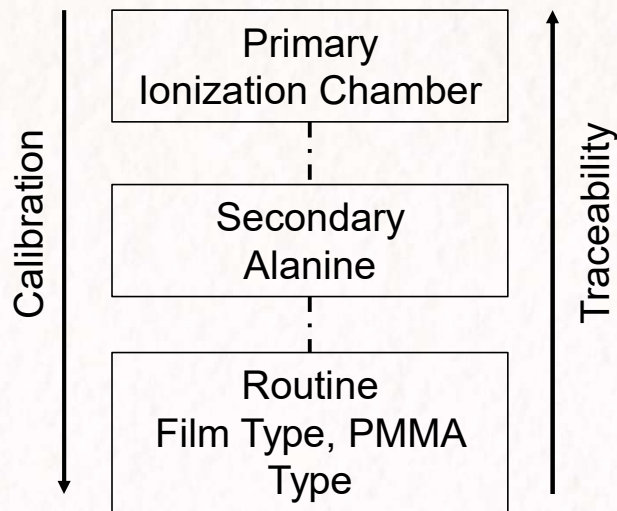

Laboratory

Laboratory Calibration

- ❑ Irradiation of dosimeters in the reference radiation field of a calibration laboratory (or of an in-house calibration facility) followed by “calibration verification” in the irradiation plant.

- ✓ advantages
 - easy to obtain full dose range;
 - irradiation to accurately known doses under controlled and documented conditions;

- ✓ disadvantages:
 - different conditions from real use (uncertainties);
 - transport of dosimeters (pre- and post-irradiation storage effects - uncertainties);

In-Plant

In-Plant Calibration

- ❑ Routine dosimeters are irradiated together with reference or transfer standard dosimeters in “calibration phantoms” in the irradiation plant.

- ✓ advantages
 - calibration and production conditions are similar (environmental conditions);
 - For gamma: $T(\text{effective}) = T(\text{min}) + \frac{2}{3}(T(\text{max}) - T(\text{min}))$.
 - For electron: $T(\text{effective}) = (T(\text{min}) + T(\text{max}))/2$

- ✓ disadvantages:
 - difficult to obtain full dose range in certain plants;
 - Use thermos label

- ✓ care must be taken:
 - to ensure that all dosimeters irradiated together receive the same absorbed dose;

Verification Dose

Why need calibration verification

- ❑ Differences in environmental conditions (temperature, dose rate, etc.) between calibration irradiator and industrial plant may lead to systematic errors.
- ❑ Transport of dosimeters between the calibration irradiator and industrial plant may also introduce errors.
- ❑ These errors can be detected by irradiating routine dosimeters alongside reference dosimeters in the industrial plant – Calibration Verification.

How to do

- I. Irradiate routine dosimeters alongside reference dosimeters in the industrial plant
- II. Use at least three dose points with two reference dosimeters and four routine dosimeters at each point
- III. Determine difference between dose readings of routine and reference dosimeters
- IV. Examine results for systematic differences and correct routine dosimeter calibration if necessary

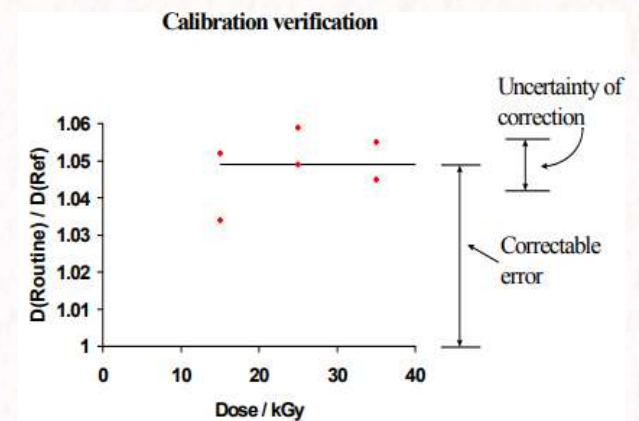

Calibration

Determine relationship between response of a dosimeter and absorbed dose.

Influence factors:

- dose rate
- Temperature
- storage (time, conditions)
- Humidity
- light

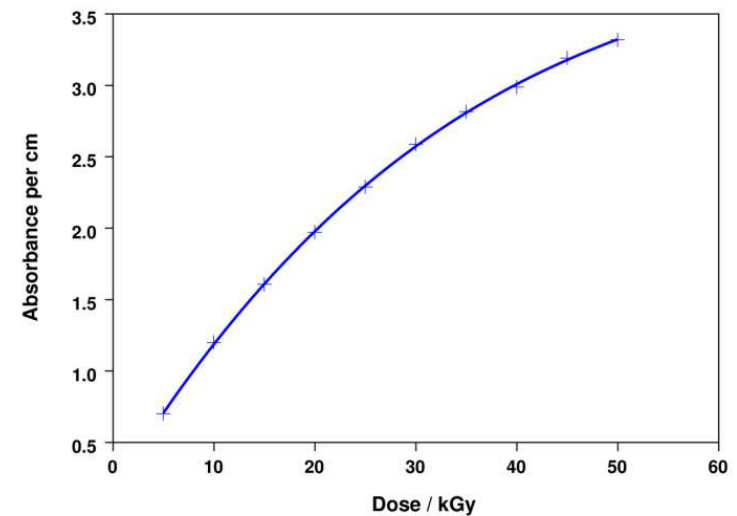

Regulatory standards, such as ISO 11137, impose specific requirements:

“Dosimetry used in the development, validation and routine control of the sterilization process shall have measurement traceability to national or international standards and shall have a known level of uncertainty.” (4.3.4)

The aim of the calibration is to ensure that dose measurements can be related to accepted standards.

through a series of known steps, each with a defined level of uncertainty, i.e. to ensure traceability.

1

Installation Qualification

Definitions

9.1 Installation qualification

3.16 - installation qualification - IQ

process of obtaining and documenting evidence that equipment has been provided and installed in accordance with its specification.

Keywords: Whether or not data are “in accordance with their specification” depends on agreement between supplier and user.

Definitions

International Standards:

- ISO 14470:2011 Food irradiation — Requirements for the development, validation and routine control of the process of irradiation using ionizing radiation for the treatment of food *and many others ...*

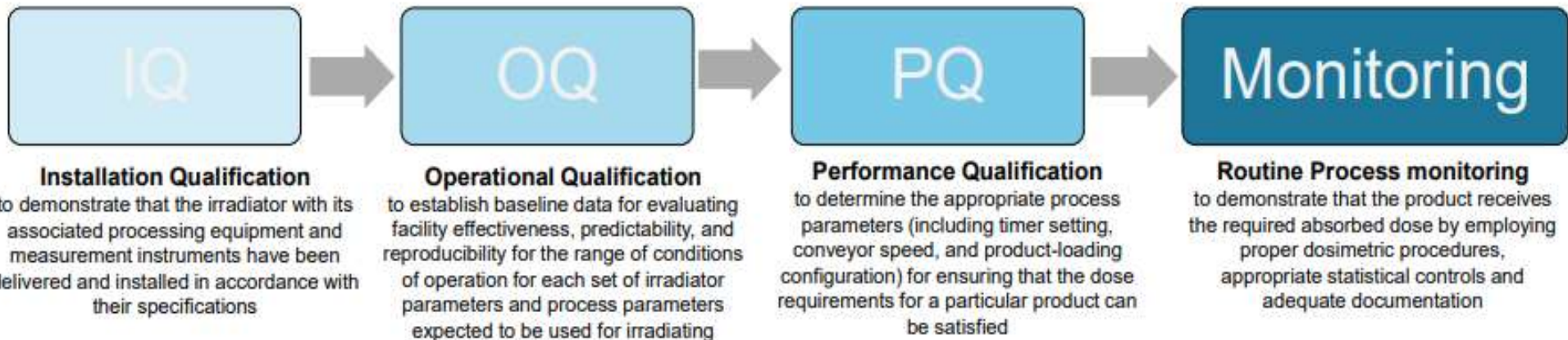

Definitions

- **Installation Qualification**

To demonstrate that irradiator has been supplied and installed in accordance with its specifications

- **Operational Qualification**

To demonstrate that the irradiator, as installed, is capable of operating and delivering appropriate doses within defined acceptance criteria

(characterize the radiation facility)

- **Performance Qualification**

To determine the appropriated process parameters for ensuring that the dose requirement for a particular can be satisfied

(dose distribution in irradiated products)

- **Process Control**

To demonstrate that the product receives the required absorbed dose by employing proper dosimeter procedures, appropriate statistical control, and adequate documentations

(monitor the irradiation process)

Gamma Parameters

- **Source Energy (MeV)**

Coming from type of radioactive. Example Co60 1.17 MeV and 1.33 MeV; Cs137 0.662 MeV

- **Dose Rate**

Quantity of dose per unit time – Controls the absorb dose of the product

- **Time of Irradiation**

The relation between dose rate and density products creates the dose rate and consequence the time being exposed to ionising radiations

- **Carrier Geometry (Tote/ Hanging)**

Dimensions of irradiated product to the source (Source overlap/ or product overlap)

EB/ Xrays Parameters

- **Beam Energy (MeV or KeV) Million/ or Kilo Electron Volt**
Energy (speed) of electrons – Controls the penetration of product density
- **Beam Current (mA or μ A) milli/ or micro amperes**
Quantity of electrons produced/ populations of electrons/ electron fluxe – Controls the absorb dose of the product
- **Conveyor Speed/ or Time of Irradiations (m/min) meter per minutes**
The relation between speed and beam creates the dose rate and consequence the time being exposed to ionising radiations
- **Beam Power (kW) kilo Watt**
Radiation Power – $P = V.I$ (Example. kW = V (10 MeV) * I (5 mA) = 50 kW – Gives the throughput of irradiation
- **Scanned Lenght (m or cm) meters or centimeters**
Dimensions of irradiation zone to the product movement at a specified distance from the accelelator window

2

Operational Qualification

Definitions

9.2 Operational qualification

3.22 Operational qualification - OQ

process of obtaining and documenting evidence that installed equipment operates within predetermined limits when used in accordance with its operational procedures

9.2.2 OQ shall be carried out by irradiating appropriate test material to demonstrate the capability of the equipment to deliver the sterilization process that has been defined.

Keywords: Provides baseline data to show consistent operation of the facility

Operational Qualification

12.4.1 Requalification of a sterilization process shall be carried out for defined product and specified equipment; it shall be performed at defined intervals and after the assessment of any change (see 12.5). The extent to which requalification is carried out shall be justified.

12.5.1 Any change in the irradiator which could affect dose or dose distribution shall be assessed. If one or both of these is judged to be affected, then a repeat of part or all of IQ, OQ and/or PQ shall be carried out.

Operational Qualification

9.2 Operational qualification

3.22 Operational qualification - OQ

Process of obtaining and documenting evidence that installed equipment operates within predetermined limits when used in accordance with its operational procedures

9.2.2 OQ shall be carried out by irradiating appropriate test material to demonstrate the capability of the equipment to deliver the sterilization process that has been defined. provides baseline data to show consistent operation of the facility

9.2.4 Dose maps must be made with fully loaded irradiation chamber

9.2.5 OQ dose mapping shall be carried out on a sufficient number of irradiation containers to allow determination of the distribution and variability of dose between containers.

4 Quality Management System Elements

4.3 Product realization

4.3.4 Dosimetry used in the development, validation and routine control of the sterilization process **shall have** measurement traceability to national or international standards and **shall have** a known level of uncertainty.

5 Sterilizing agent characterization

5.1.1 The type of radiation to be used in sterilization processing shall be specified.

5.1.2 For electrons or X-rays, the energy level of the electron beam shall be specified. If the energy level for **electrons exceeds 10 MeV** or the energy level for electrons used to **generate X-rays exceeds 5 MeV**, the potential for induced radioactivity in product shall be assessed. The outcome of the assessment and the rationale for decisions reached shall be documented.

Note: US FDA is unconcerned with x-ray energy up to 7.5 MeV, for medical devices. For food, the limit remains at 5 MeV.

Gamma

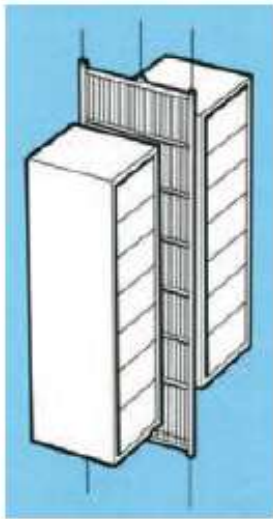

Source overlap

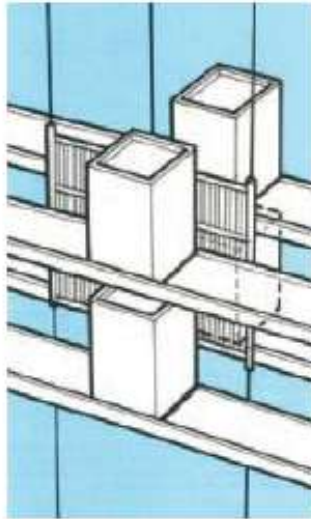

Product overlap

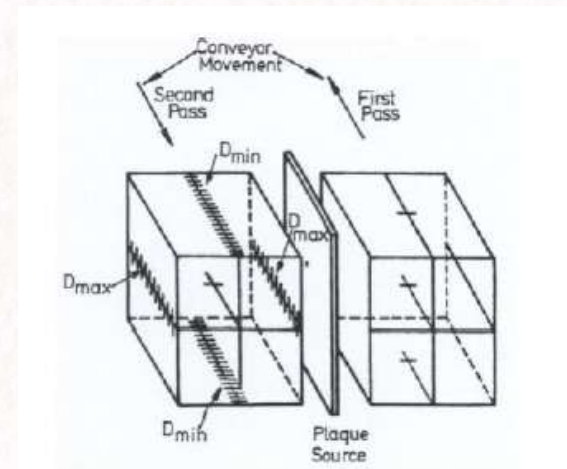

Note: Dosimeter placement for OQ dose mapping may depend on source – product arrangement

Gamma

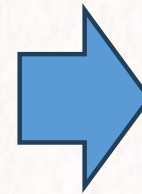
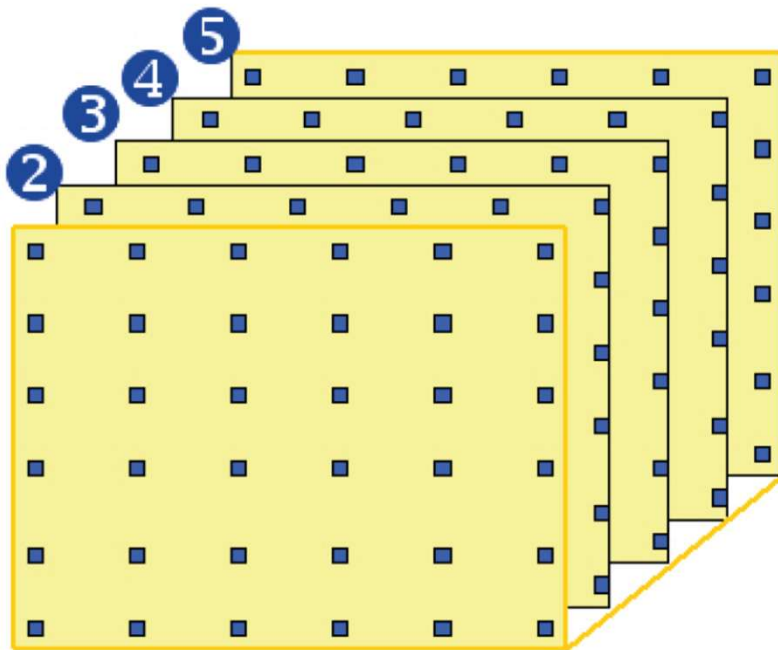

The number of dosimeter depends on the characteristic of irradiator.

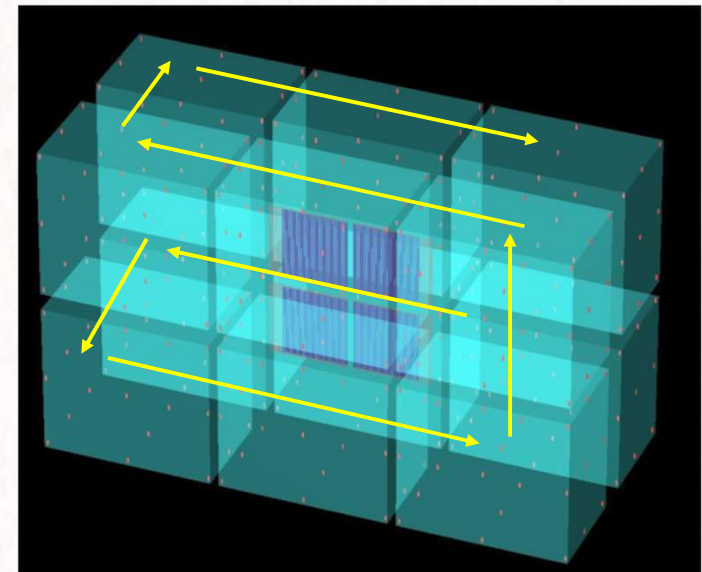

eBeam

- ❖ Determination of operating parameters

Based on the mathematical equation from NIST, the dose at the material surface can be estimated.

$$\text{Dose at Surface} = \frac{\text{Beam current } (\mu\text{A}) \times \text{Stopping Power Collision } (\text{MeV} \frac{\text{cm}^2}{\text{g}})}{\text{Scan Width (cm)} \times \text{Conveyor Velocity } (\frac{\text{cm}}{\text{s}})}$$

- Energy = 10 MeV
- Stopping power collision pada 10 MeV water density = 1.968 MeV cm²/g
- <https://physics.nist.gov/PhysRefData/Star/Text/ESTAR.html>



Beam Width (cm) 10 X length (cm) 10
Beam Length (cm) 10 Energy (MeV) 10 Y length (cm) 10
Beam centered on product Electron Z length (cm) 10

Beam Direction Back (-Y) Cc

Foil (cm) Source to foil face (cm) 28

foil face to product back (cm) 52

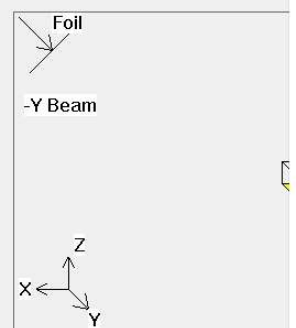

Plot Product Only Remove air in pro

Run Mode Solid Material Mater

Mesh X 19 Y 60 Z 3

Num Proc = 1 Particles/Process =

Run PENELOPE Stop

Welcome to PUFFIN
(Penelope User Friendly Fast Interface)
==>Please change to the run directory (Ch

Mute Start Video Participants Chat New share Pause Share Remote control Apps More

Change Directory C:\PUFFIN2024

You are screen sharing Stop share

Select Beams Front (Pos Y) Above (Pos Z) Max % unc Min % unc DUR
 Left (Neg X) Right (Pos X) 0 0 0 2D-DUR
 Back (Neg Y) Below (Neg Z)

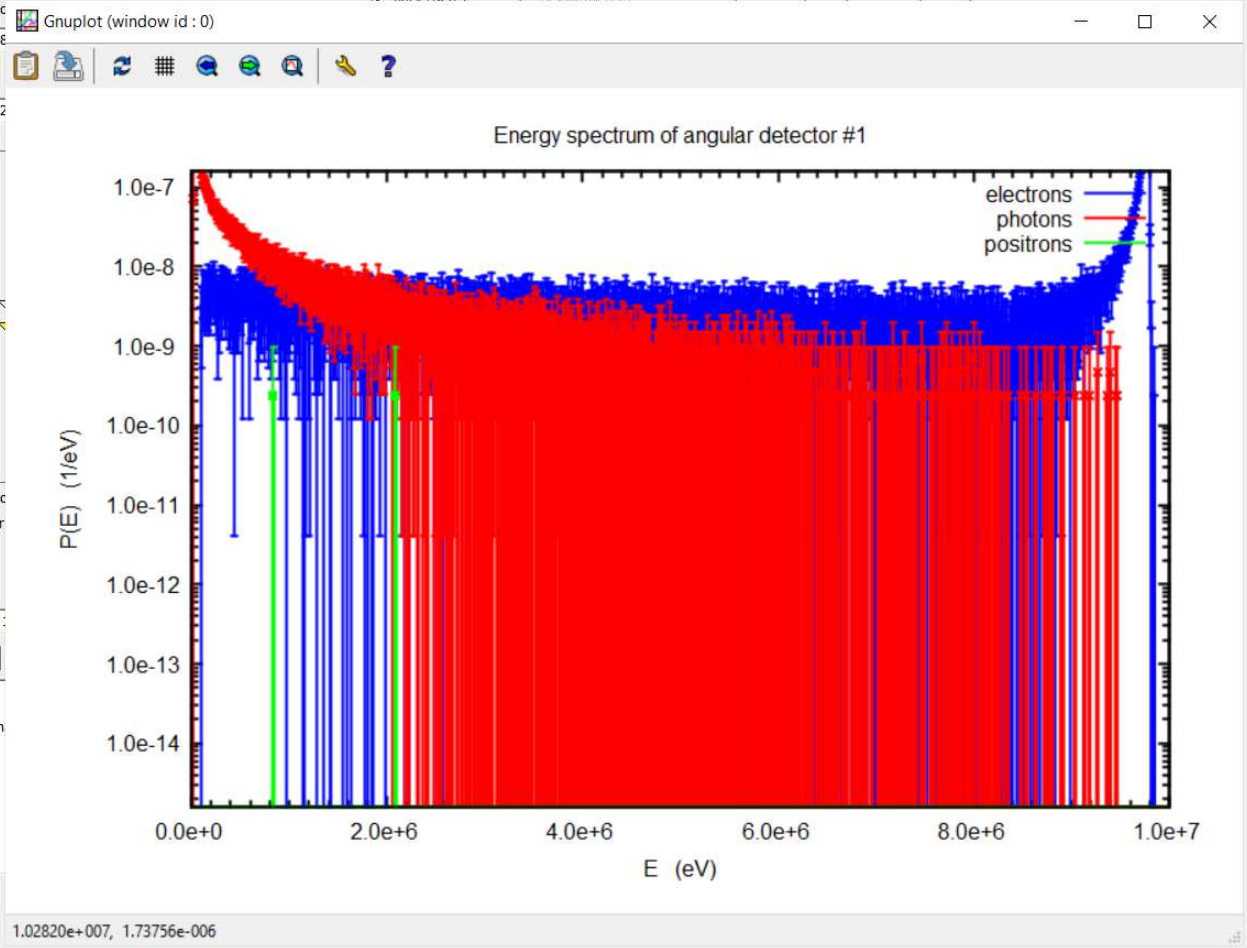

1.02820e+007, 1.73756e-006

eBeam

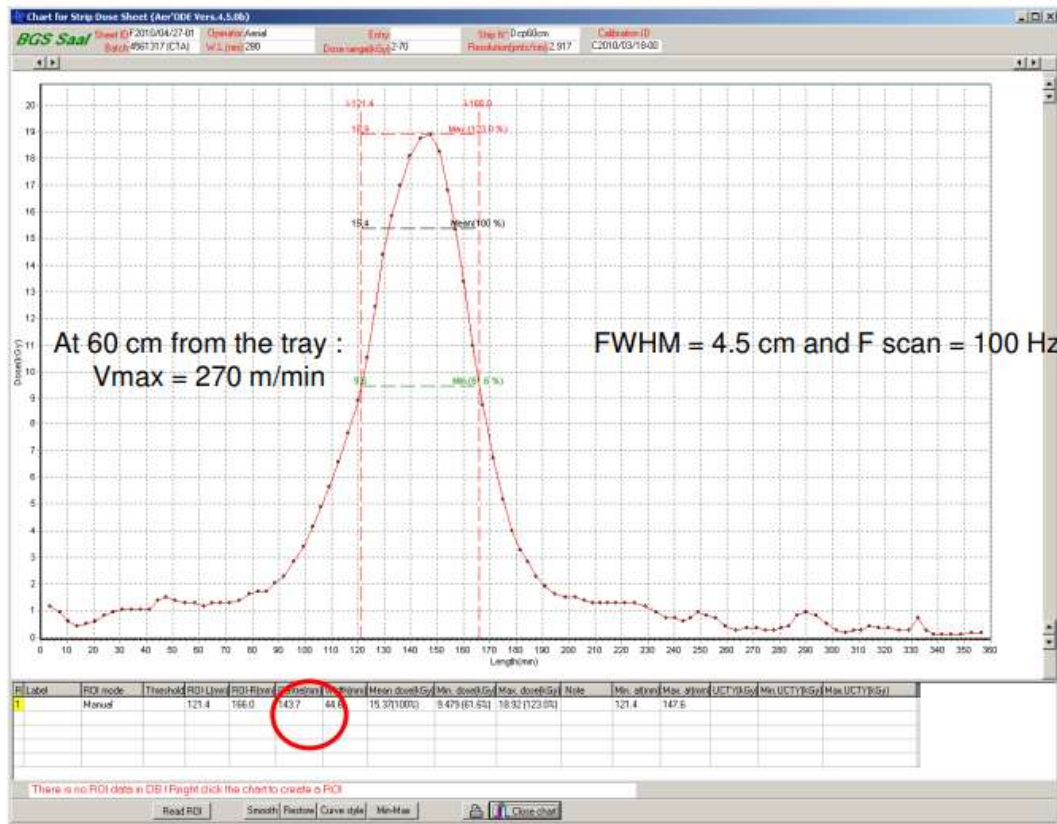

eBeam

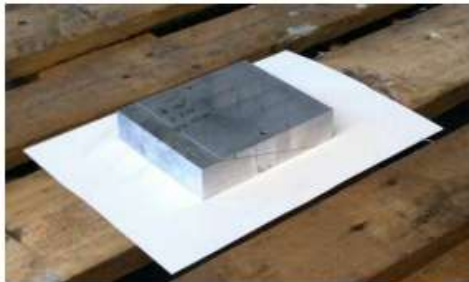

Density : 2.73 g/cm³
Angle : 16 °

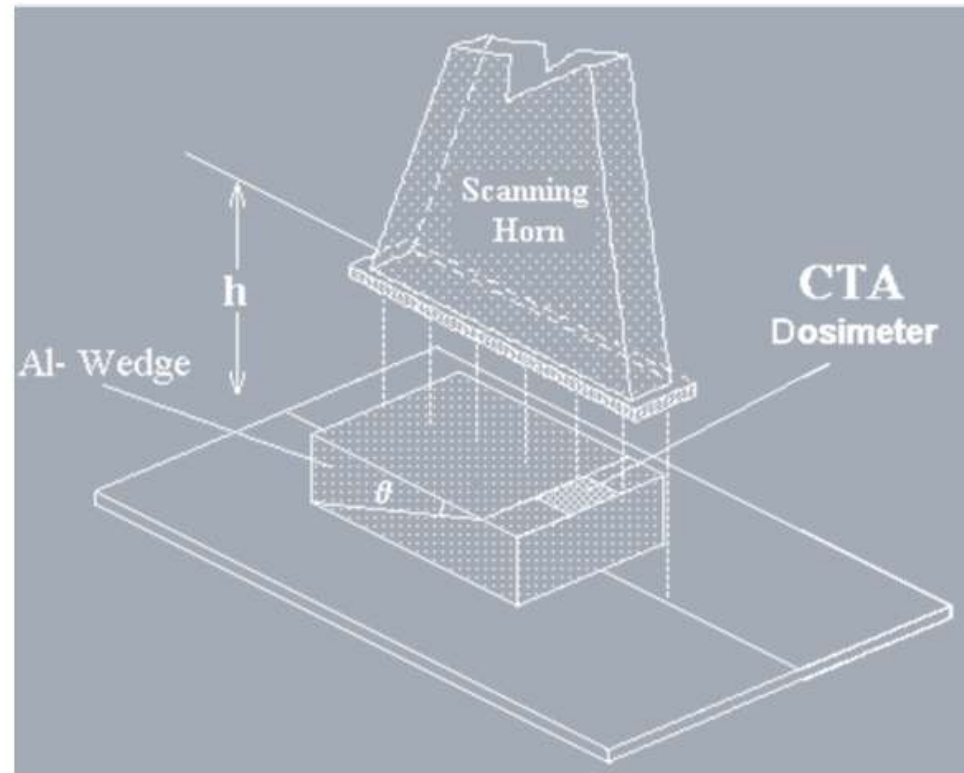

eBeam

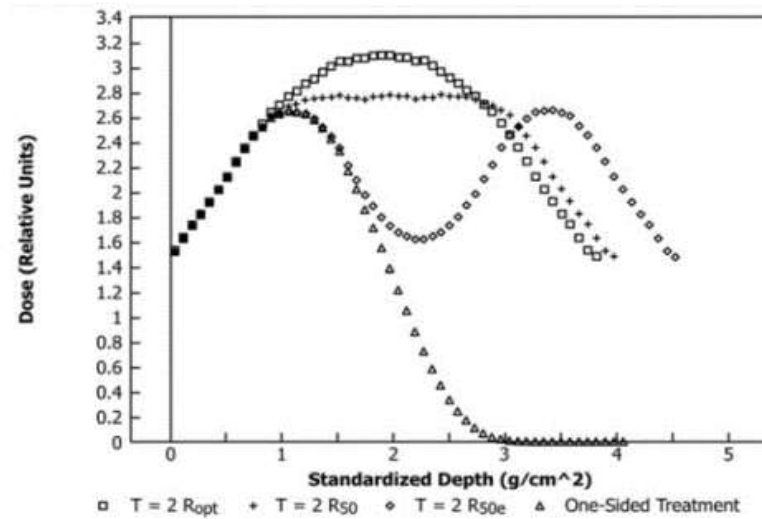
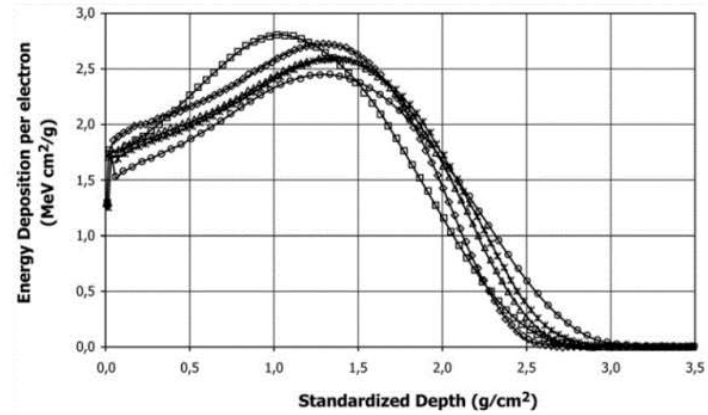
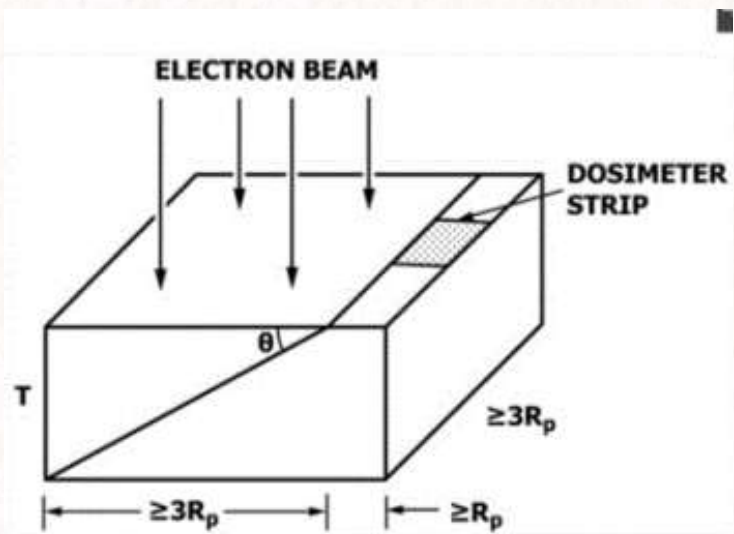

Electron Depth Dose in Water Density

Build up dose can increase up to 30%

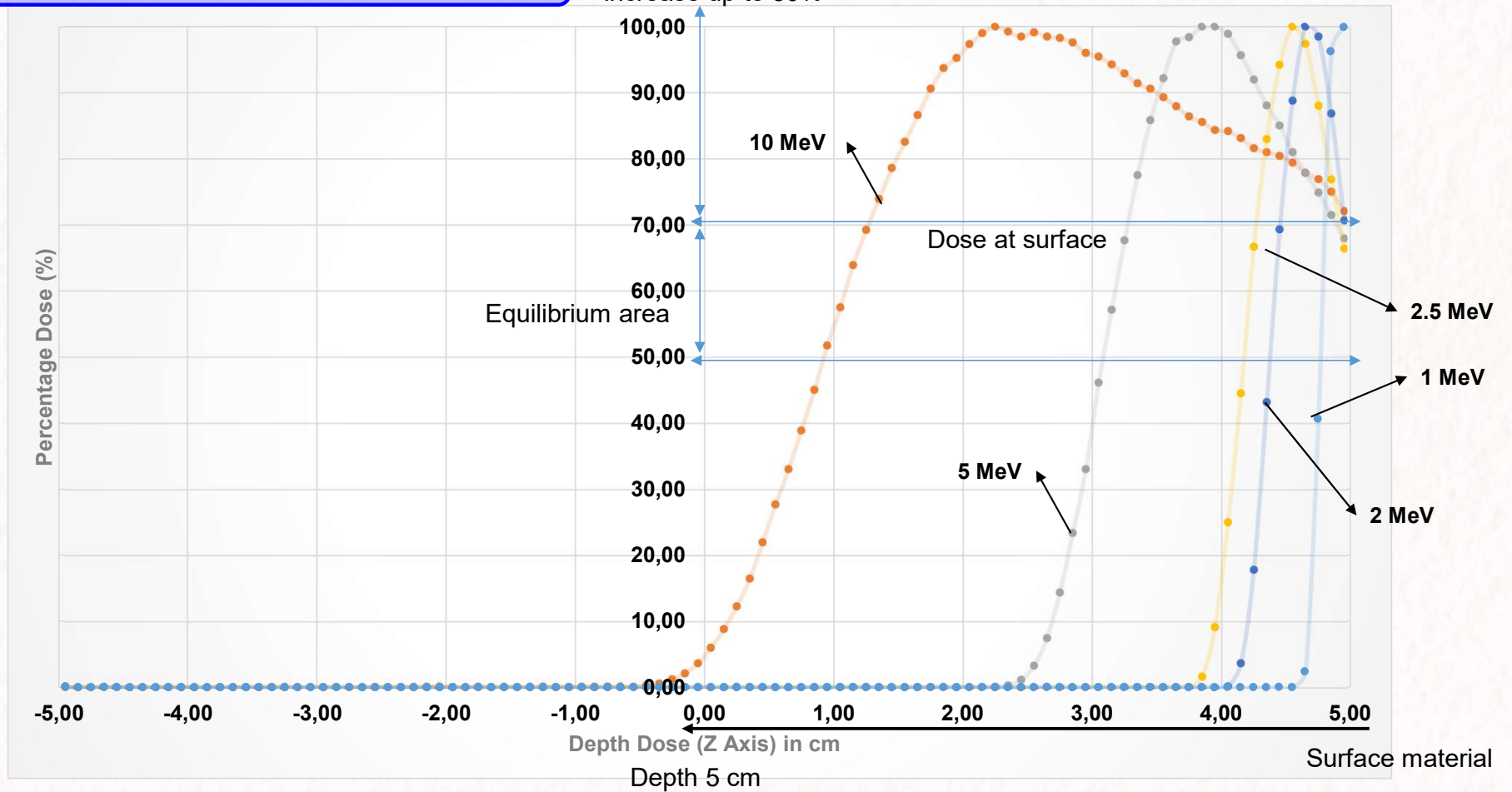

10 MeV is about 5 cm in water density

eBeam

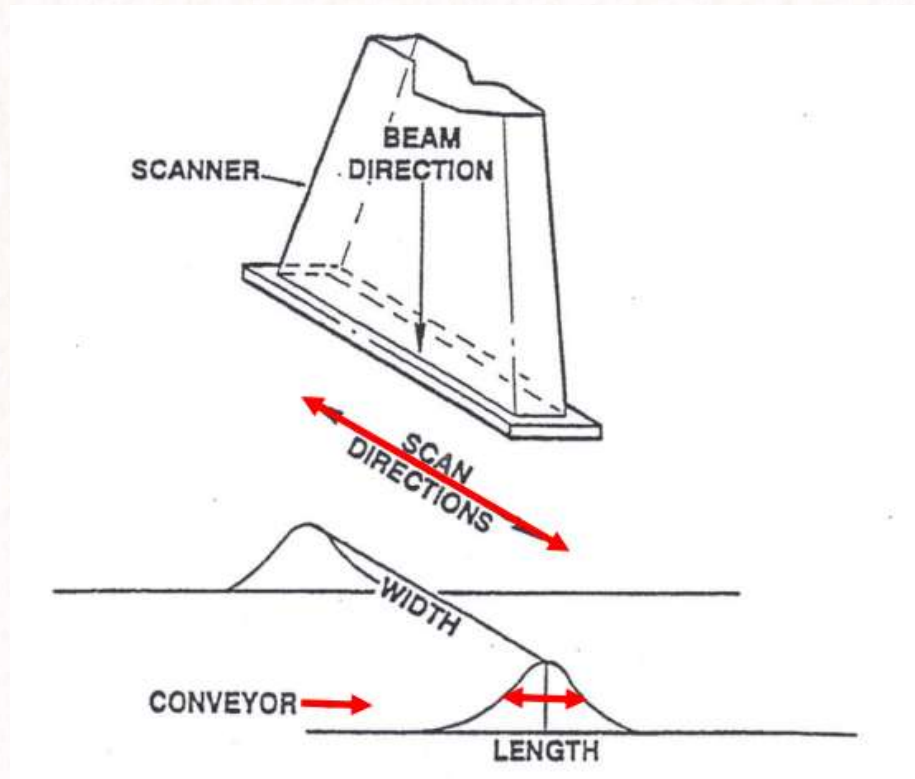

eBeam

Conveyor speed control

| First part of tray (before the beam stop) | | Second part of tray (after the beam stop) | |
|--|---------------------------|--|---------------------------|
| Duration s | Calculated speed m/min | Duration s | Calculated speed m/min |
| 2,98 | 5,03 | 3,13 | 4,79 |
| 3,04 | 4,93 | 2,94 | 5,10 |
| 3,12 | 4,81 | 2,94 | 5,10 |
| 2,99 | 5,02 | 3,07 | 4,89 |
| 3,08 | 4,87 | 3,13 | 4,79 |
| 2,85 | 5,26 | 3,03 | 4,95 |
| 3,03 | 4,95 | 2,98 | 5,03 |
| 3,07 | 4,89 | 3,05 | 4,92 |
| 3,02 | 4,97 | 3,02 | 4,97 |
| 3,02 | 4,97 | 3,03 | 4,95 |
| 2,98 | 5,03 | 3,09 | 4,85 |
| 3,09 | 4,85 | | |
| Average | 4,97 | Average | 4,94 |
| Standard dev. | 0,12 | Standard dev. | 0,11 |
| CV% | 2,4% | CV% | 2,2% |

→ no significant difference in speed between the conveyors located before and after the beam stop

eBeam

Process Failure Test

Conveyor shut down

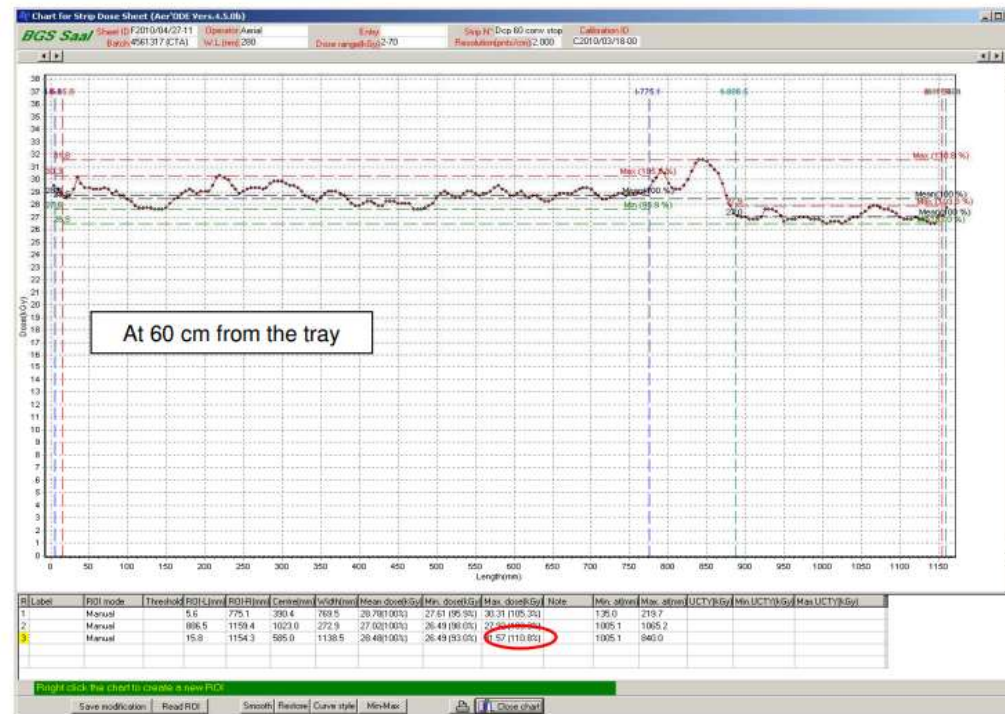

eBeam

Scanning width and Uniformity

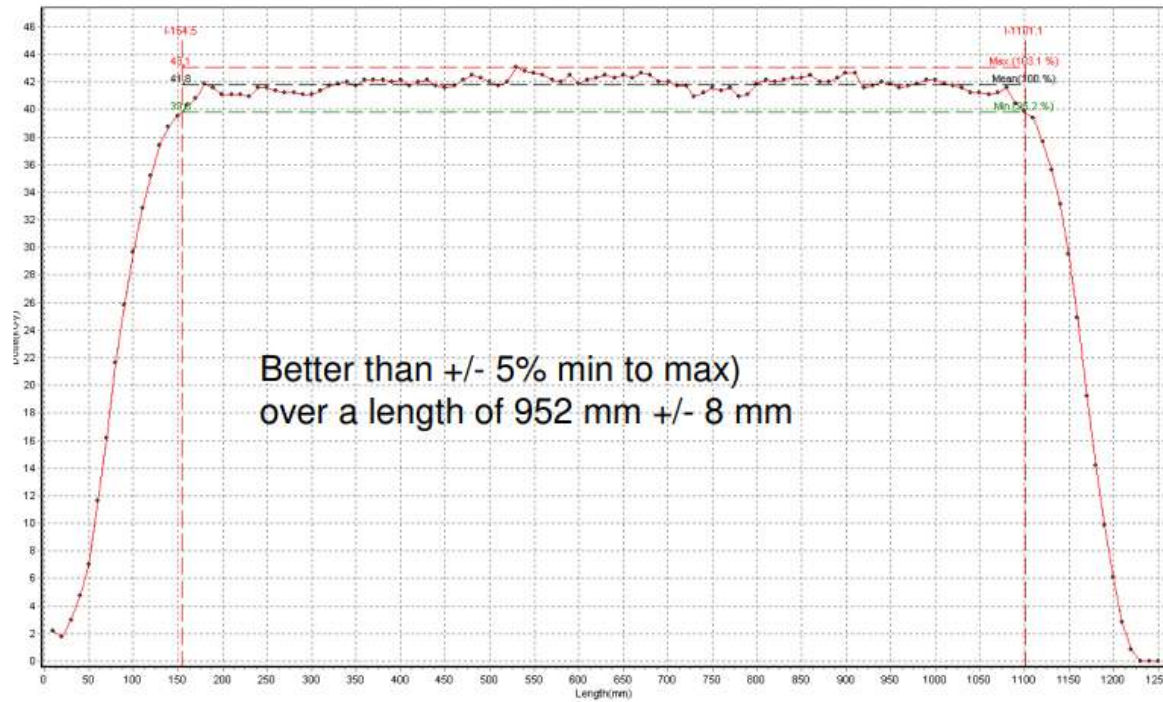

Better than +/- 5% min to max)
over a length of 952 mm +/- 8 mm

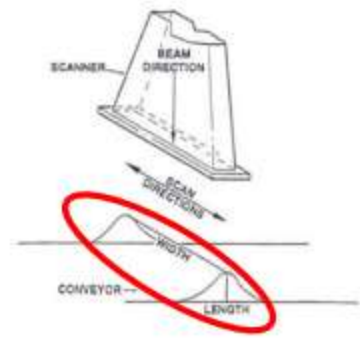

3

Performance Qualification

Performance Qualification

9.3.1 Concerns dose mapping of real product

to identify the location and magnitude of minimum and maximum doses and to determine the relationship between the min and max doses and the routine monitoring dose

It is impossible to measure dose everywhere in/on an irradiated product. Where to measure?

Strategies for dose mapping based on:

- OQ measurements
- Inhomogeneous product distribution, orientation, voids, interfaces.
- Monte Carlo calculations of dose distributions can help choosing measurement locations and might in the future replace (at least some) measurements

Performance Qualification

9.3.1 Concerns dose mapping of real product

to identify the location and magnitude of minimum and maximum doses

And

to determine the relationship between the min and max doses and the routine monitoring dose

$$D_{\min} \geq D_{\text{Ster}}$$

$$D_{\max} \leq D_{\max, \text{acc}}$$

D_{\min} determined by sterilization requirements

D_{\max} determined by radiation-induced changes in product

4

Process Control

Process Control

General requirements of dose mapping:

1. over a range of operating parameters covering the operational limits;
2. density within the range of use (more is better);
3. at least three irradiation containers to be dose mapped;
4. to place dosimeters in a three dimensional array including surface;
5. mathematical modelling to optimize the positioning of dosimeters;
6. to establish the effect of process interruption on the dose;
7. to determine relationships between characteristics of the beam, the conveyor speed and the magnitude of dose at a defined location

Process Control

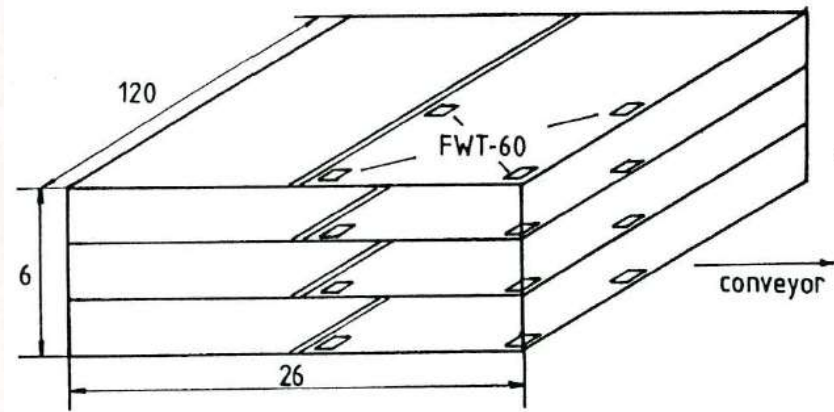

Key point: Higher density, lower penetrations

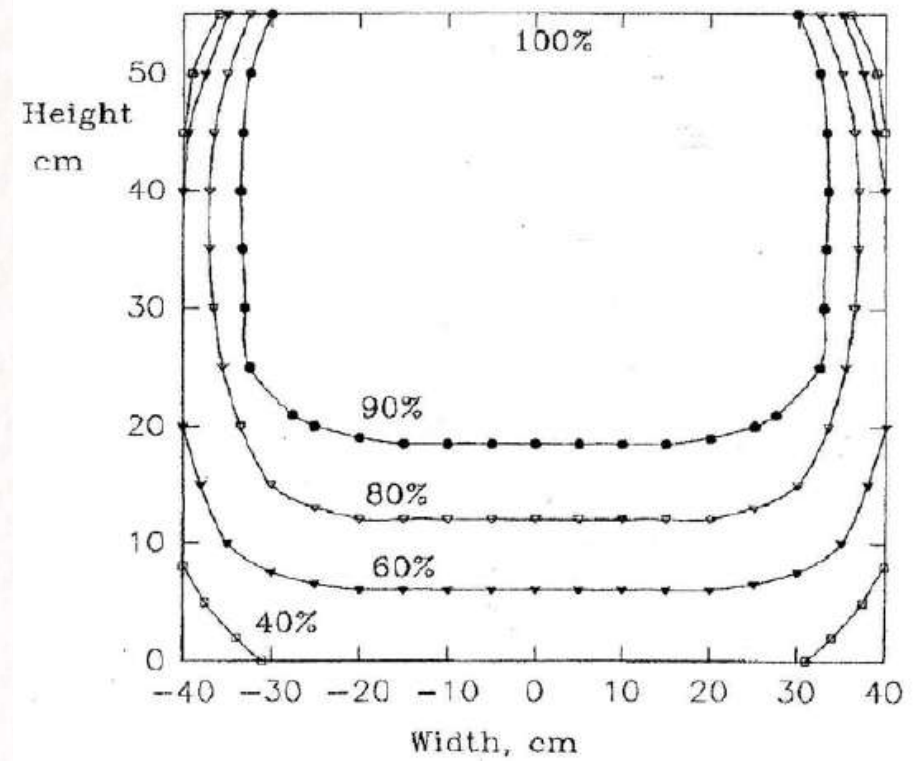

Process Control

Dose (kGy)

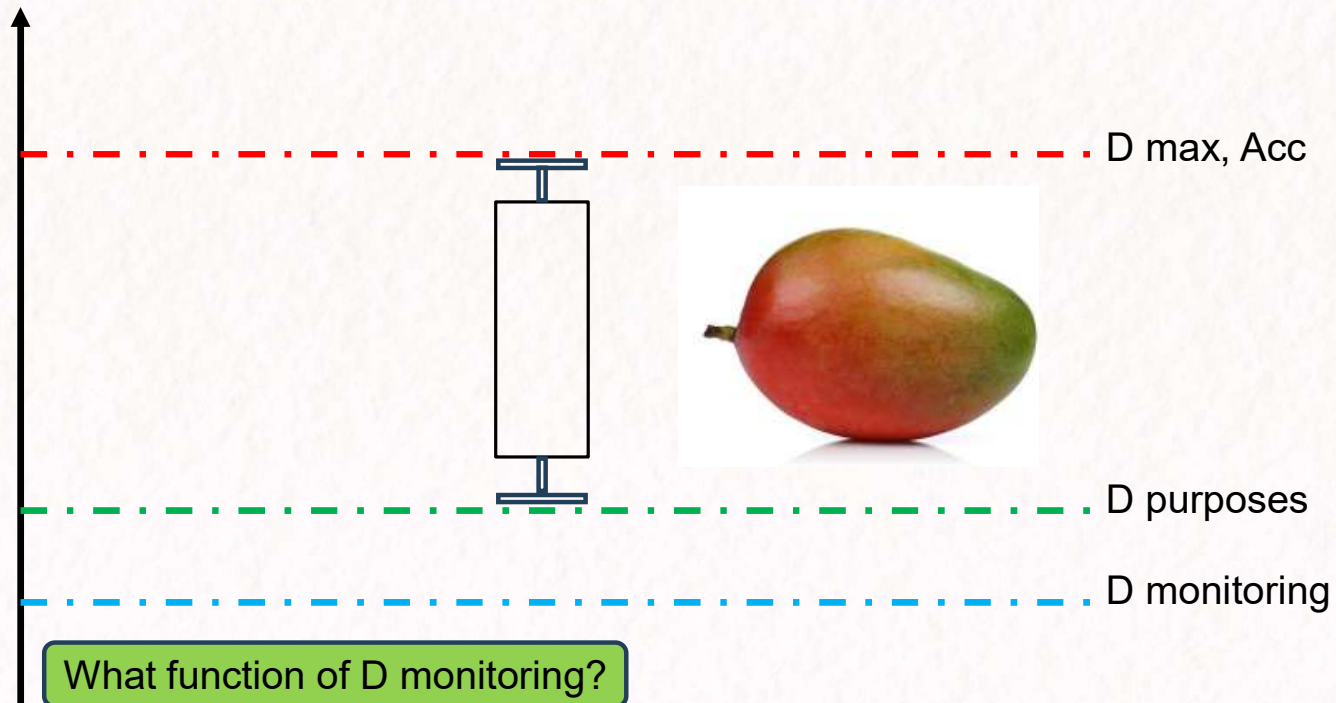

Process Control

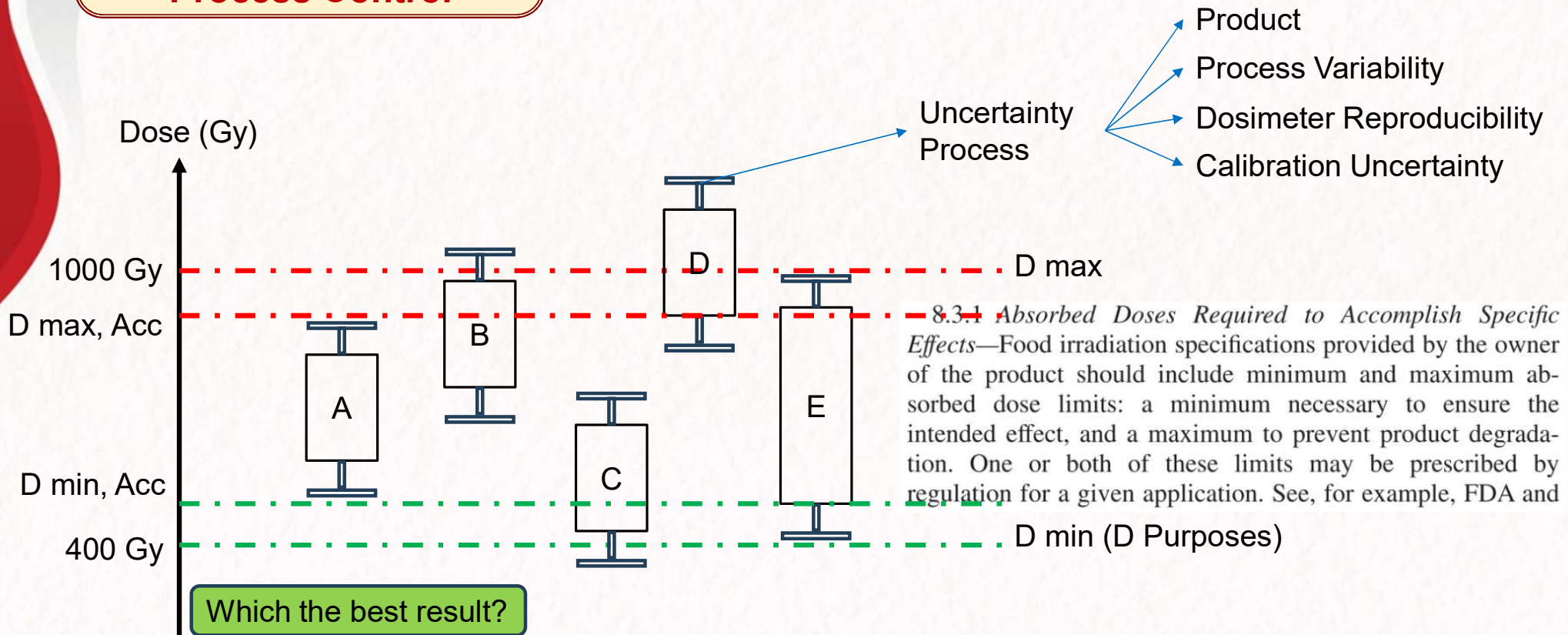

Process Control

Experimental

- GEX Windose B3 and alanine were used for dose mapping
- 10 MeV E-Beam double sided irradiation along the Z axis
- Dosimeters placed at suspected minimum and maximum dose zones

Organized box

- DUR (alanine) = 1.55
- DUR (B3) = 1.57



Monte Carlo

Organized box

- DUR = 1.67

Unorganized box

- DUR (alanine) = 1.76
- DUR (B3) = 1.79



Monte Carlo

Unorganized box

- DUR = 1.88

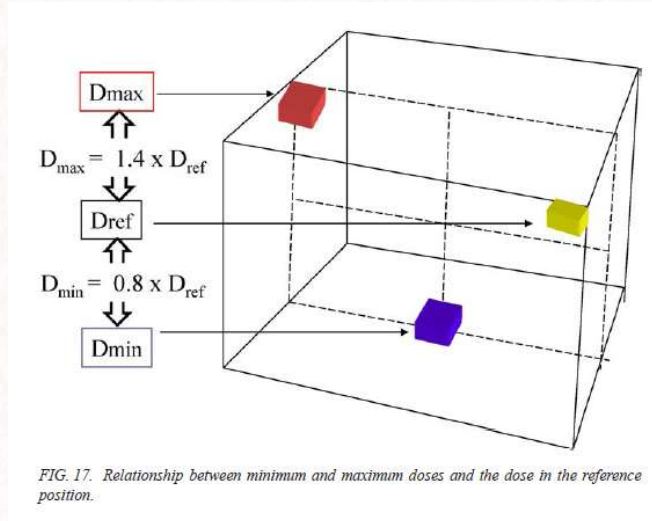
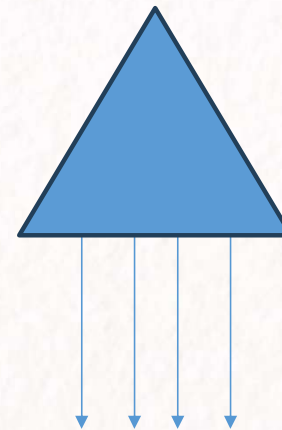
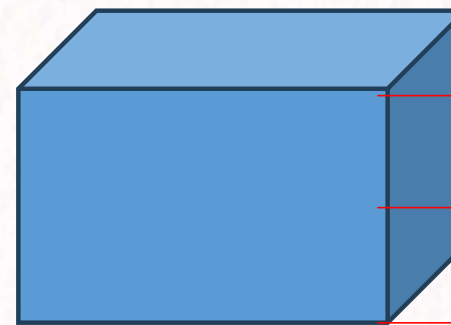

FIG. 17. Relationship between minimum and maximum doses and the dose in the reference position.



D max, Acc
D purposes



D monitoring



BRIN
BADAN RISET
DAN INOVASI NASIONAL



**HAKTEKNAS
2024**
Riset dan Inovasi untuk
Indonesia Maju



**NUSANTARA
BARU
INDONESIA
MAJU**



Terima Kasih

THANK YOU



B.J. Habibie Building
Jl. M.H. Thamrin 8, Jakarta 10340, Indonesia



www.brin.go.id



Brin Indonesia



@brin_indonesia



@brin.indonesia



Bridging Sciences
Empowering Talents

@dpk brin